

MEMO

To: Knoxville- Knox County Metropolitan Planning Commission
From: Peter Ahrens
CC: Gerald Green
Date: 1/4/2017
Re: South Waterfront Form Base Code Updates - 1-A-17-OA

Comments: Good codes are the foundation in which great communities are built. The South Waterfront Form Base Code was adopted in 2007, and there have been very few changes to the code in the last nine years. As we begin to see more development coming to the South Waterfront we thought this would be a good time to make some needed changes to remove some of the redundancies and confusions in the current South Waterfront Form Based Code. The proposed updates will not change the intent of the existing code. Encouraging pedestrian & environmentally friendly development is still the focus and will remain the focus.

The goal is to make it easier for property owners to navigate the South Waterfront Form Based Code and to meet the code requirements. The proposed updates are considered to be of the housekeeping nature and are attached for review.

Knoxville South Waterfront

CREATING AN ACTIONABLE AND INSPIRATIONAL VISION

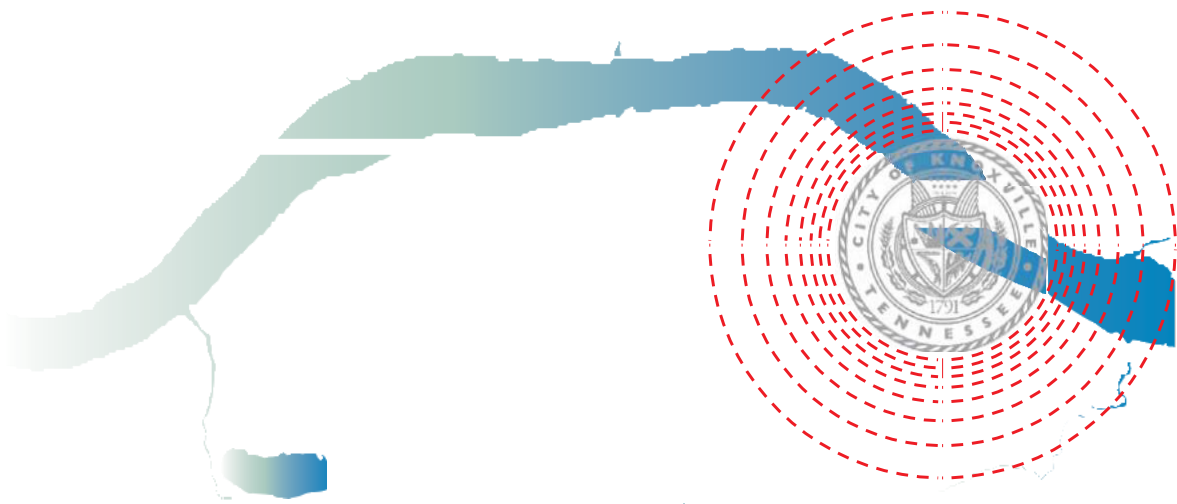

SECTION 4.1: SOUTH WATERFRONT DISTRICT (SW-)

Regulations for Designing the South Waterfront

ADOPTED BY THE KNOXVILLE CITY COUNCIL

FEBRUARY 27, 2007

ORDINANCE: O-29-07

AMENDED

JULY 21, 2015

ORDINANCE: O-129-2015

CITY OF KNOXVILLE, TENNESSEE

REVISIONS TABLE

<u>DATE</u>	<u>ORDINANCE</u>	<u>DESCRIPTION</u>
2/27/2007	O-29-07	Initial Adoption
2/27/2007	O-30-07, O-31-07 O-32-07, O-33-07	City of Knoxville Zoning Ordinance Amendments Related to SW Code
1/13/2009	O-1-2009	Revisions to the Streetscape Standards
2/19/2013	O-30-2013	Removal of Administration Section to General Provision Section, Article 4, Section 4.0
07/21/2015	O-126-2015	Amendments related to Urban Agriculture

CONTENTS

4.1.1. General Provisions	1	4.1.6. Riverscape Standards	97
A. Applicability	1	A. Vision and Intent	97
B. Purpose	1	B. Riverbank	98
C. Conflicting Provisions	1	C. Riverwalk	98
D. Approval Procedures	1		
4.1.2. Vision Plan & Regulating Plan	2	4.1.7. Stream Buffer Standards	99
		A. Vision and Intent	99
		B. Stream Buffer	100
4.1.3. Property Development Standards by District.12		4.1.8. Marina Standards	101
A. Check List	12	A. Vision and Intent	101
B. SW1 Old Sevier and Scottish Pike	14	B. Siting	102
C. SW2 River Rd, Goose Creek Row and Island Home Ave... 21		C. Dimensions	102
D. SW3 Sevier Avenue	29	D. General Standards	104
E. SW4 City View, Campus Cove and Quay Village	37		
F. SW5 Bell Tower Walk	45	4.1.9. Glossary and Definitions	105
G. SW6 Henley Gateway	53		
H. SW7 Waterfront Marketplace	61		
4.1.4. General Development Standards	69		
A. Uses	69		
B. Building Envelope and Materials	70		
C. Frontage Typologies	71		
D. Off Street Parking and Loading	73		
E. Signage	74		
F. Lighting and Noise	76		
4.1.5. Streetscape Standards	78		
A. Vision and Intent	78		
B. Path, P-20-12	79		
C. Rear Alley, RA-20-12	80		
D. Street, ST-42-24-PL	81		
E. Street, ST-50-30-2PL	82		
F. Street, ST-50-30-PL	83		
G. Side Road, SR-56-36-2PL	84		
H. Street, ST-70-40-PL-2BL	85		
I. Commercial Street, CS-58-38-2PL-BR	86		
J. Street, ST-52-22-BR	87		
K. Boulevard, BLVD-70-50-1-PL-2BL-BR	88		
L. Street: ST-62-38-2PL	89		
M. Street: ST-58-36-2PL	90		
N. ST-68-46-2PL-2BL	91		
O. Street: ST-60-38-2PL	92		
P. Street: ST-50-22	93		
Q. Street: ST-58-36-2PL	94		
R. Street: ST-44-22	95		
S. Street: ST-62-38-2PL	96		

4.1. SOUTH WATERFRONT DISTRICT (SW-)

4.1.1. General Provisions

A. Applicability

The requirements of this section apply to all development within the South Waterfront District as designated in Sec. 4.1.2.

B. Purpose

The South Waterfront District carries out the policies of the South Waterfront Vision Plan by regulating development and land uses within the City's designated South Waterfront, consistent with the Vision Plan. More specifically, the South Waterfront District is intended to:

1. Provide standards for the continuing orderly growth and development that will assist in enhancing and maintaining a distinct community identity;
2. Create a comprehensive and stable pattern of development and land uses upon which to plan transportation, water supply, sewerage, energy, and other public facilities and utilities;
3. Ensure that proposed development is of human scale, pedestrian-oriented, energy conserving, and is designed to create attractive streetscapes and pedestrian spaces;
4. Minimize automobile congestion through pedestrian-oriented development, compact community form, safe and effective traffic circulation, and adequate parking facilities; and
5. Ensure compatibility between different types of development and land uses.

C. Conflicting Provisions

Wherever there appears to be a conflict between these district regulations and other requirements of the Zoning Ordinance or the Knoxville and Knox County Subdivision Regulations, these district regulations shall prevail. For development standards not covered in these district regulations, additional requirements may apply.

D. Approval Procedures

Sec. 4.0.2 applies to the review of all development in the South Waterfront District.

4.1.2. Vision Plan & Regulating Plan

Excerpted from the **VISION PLAN EXECUTIVE SUMMARY**

The Knoxville South Waterfront Vision and Action Plan is an effort to develop, through extensive public involvement, a coordinated plan and realistic series of prioritized actions to improve the waterfront area across from the downtown. The intent of the project is to revitalize the South Waterfront to a level that it is recognized as a citywide asset, attraction, and destination, while still preserving what makes the riverfront special to the neighborhoods.

The plan is not intended to be rigid and inflexible. It has been subjected to extensive review, discussion, and revision from all levels of government, local business and local communities. Three public workshops during the visioning process were well attended, with the final workshop drawing more than 500 people. The basic framework of the plan describes a series of public transportation and open space improvements designed to allow access and views to the water throughout the South Waterfront. The plan is designed to accommodate a realistic range of market driven redevelopment over the next 20 years.

The Vision Plan was adopted by the City Council on April 25, 2006.

THE GROWTH STRATEGY FOR THE KNOXVILLE SOUTH WATERFRONT FOR THE NEXT 20 YEARS INCLUDES THE FOLLOWING:

Type of Development	Estimated Market Study Demand	Vision Plan Approximate Capacity
Residential	2,200 units	2,200 units
Retail	60,000 square feet	420,000 square feet
Restaurant / Entertainment	30,000 square feet	60,000 square feet
Office	400,000 square feet	1,000,000 square feet
Hotel	100 rooms	160 rooms
Marina	225 slips	225 slips
Cultural / Civic Institutions	135,000 square feet	135,000 square feet
Whitewater Kayak Park	1 course on Quarry	
Garages	700 cars	
On-street Parking	790 cars	
Off-street Parking Lots	450 cars	
New Roads	11,750 linear feet	
Existing Roads - Upgrades	11,000 linear feet	
New Parks, Greenways	51.3 acres	

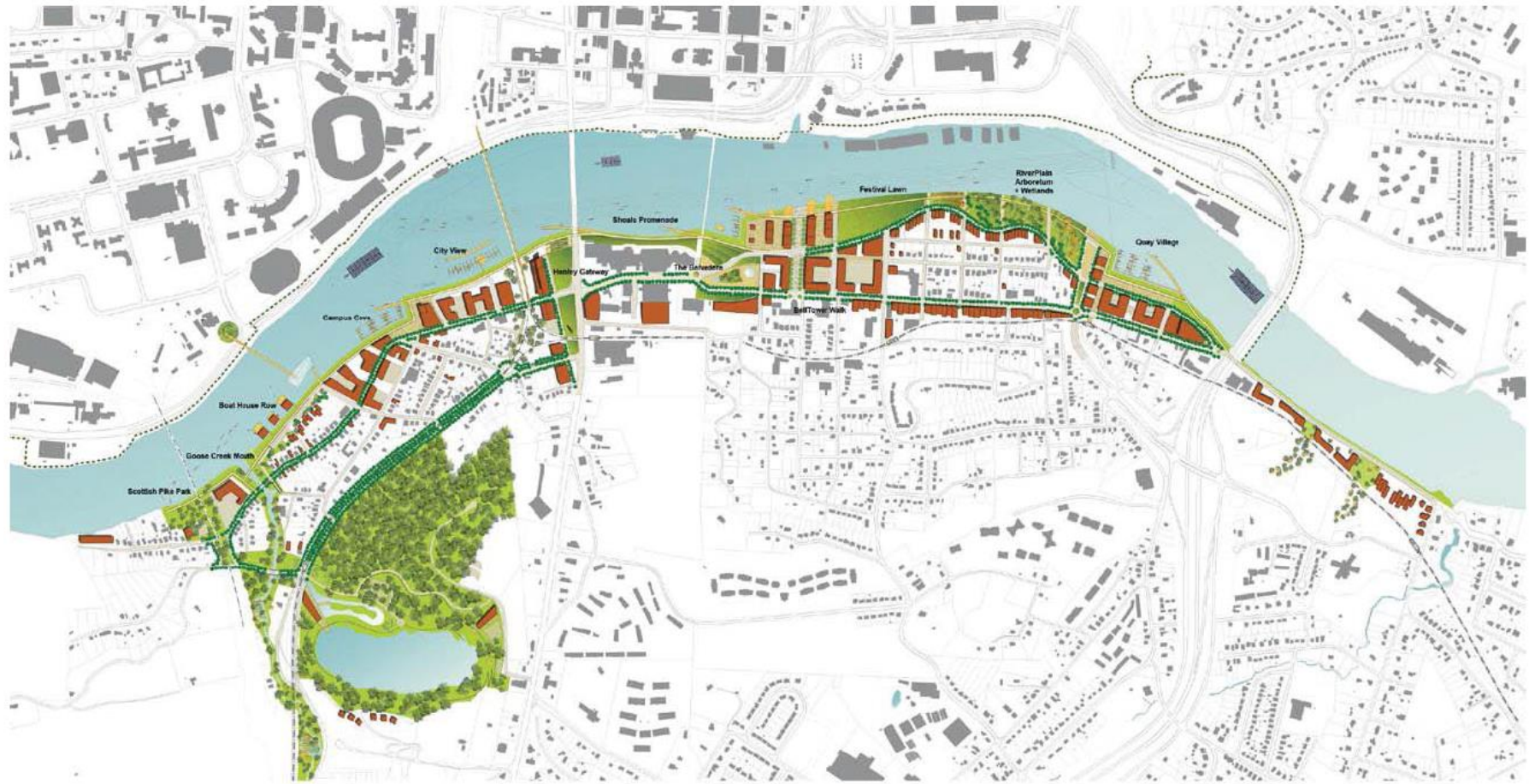

Knoxville South Waterfront

HARGREAVES ASSOCIATES · CHAN KRIEGER & ASSOCIATES · KENNEDY COULTER RUSHING & WATSON · DEVELOPMENT STRATEGIES
 MOFFATT & NICHOL · GLATTING JACKSON · JORDAN JONES & GOULDING · STUDIO FOUR DESIGN · ARCADIS G&M · DUVALL & ASSOCIATES

VISION PLAN



3-2

REGULATING PLAN

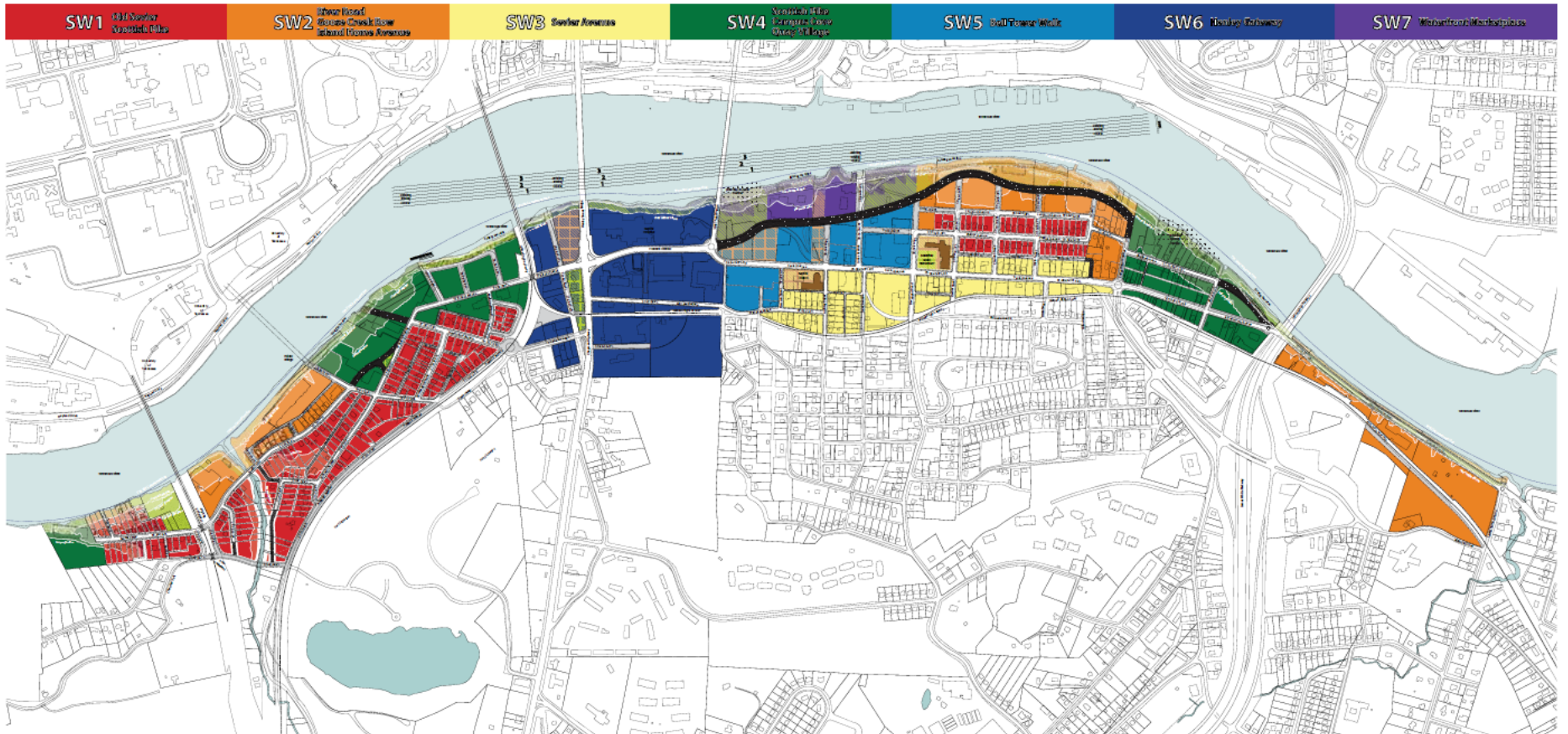

Knoxville South Waterfront

hargreaves associates . chan krieger & associates . kennedy coulter rushing & watson . development strategies
moffatt & nichol . glatting jackson . jordan jones & goulding . studio four design . arcadis g&m . duvall & associates

12-12-12
 new roads
 existing roads
 existing properties
 river setback
 existing park
 potential open space
 potential civic space
 buildable area
 new right of way alignment
 flexible road alignment



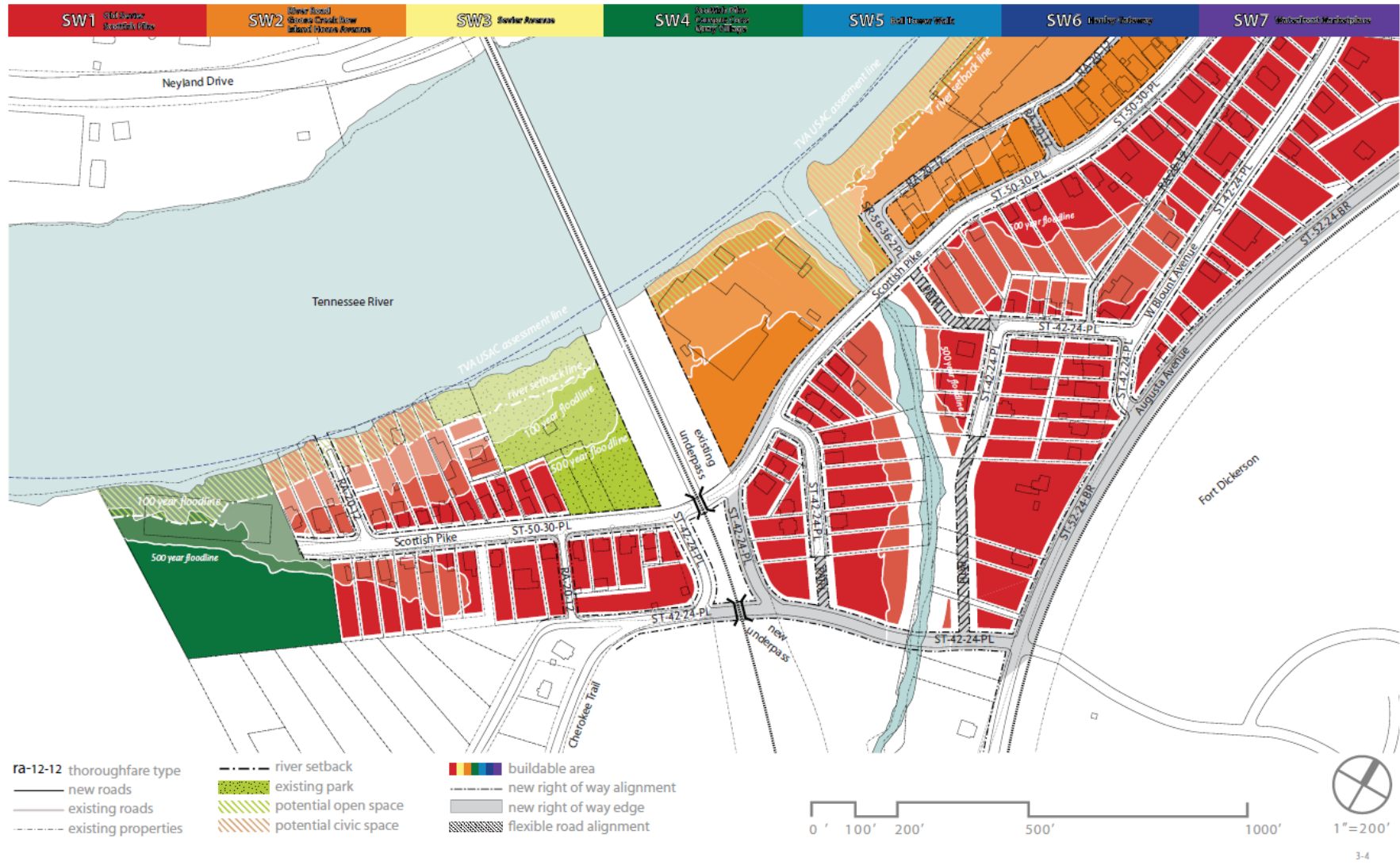

REGULATING PLAN

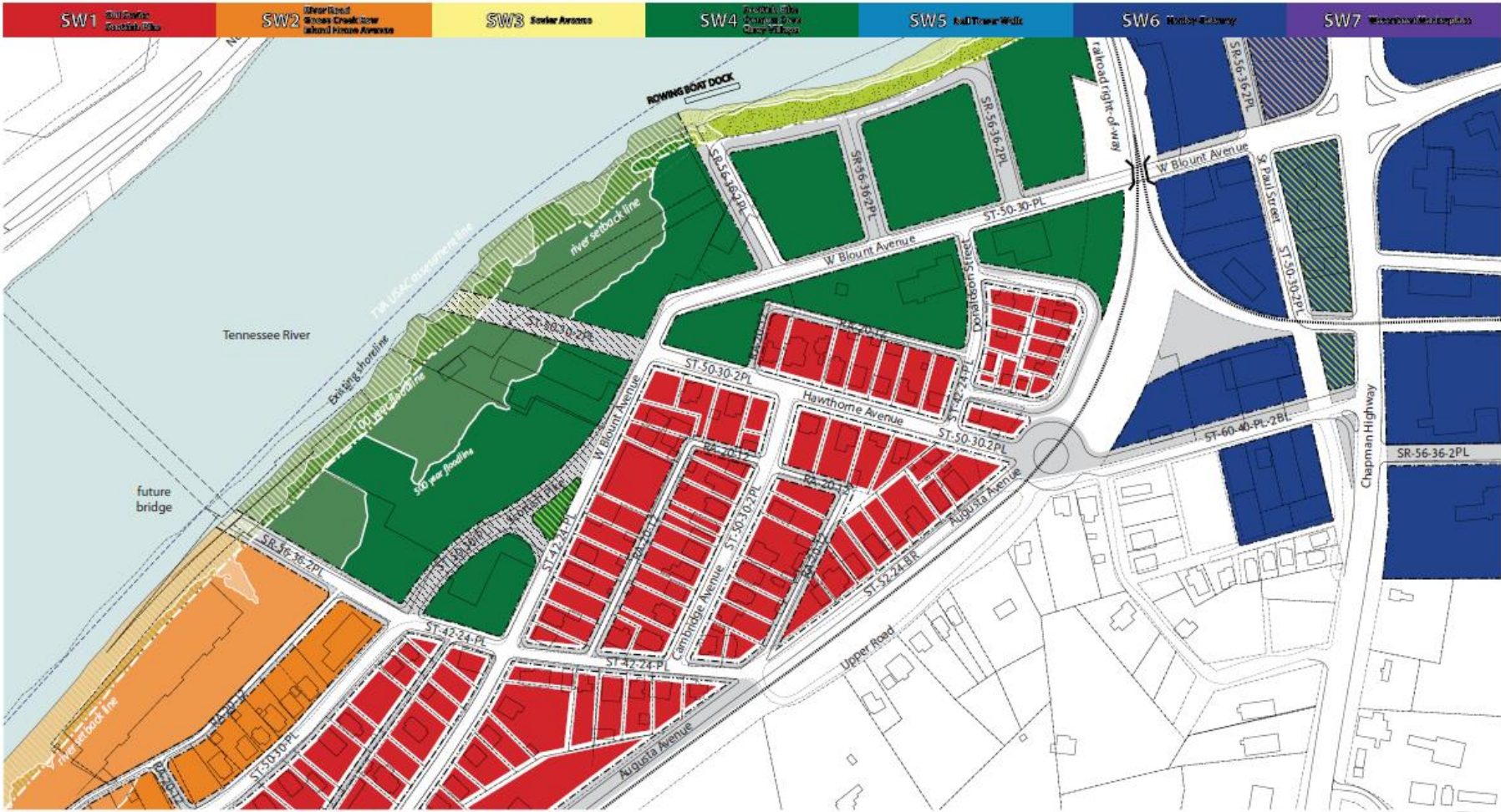

ra-12-12 thoroughfare type	--- river setback line	■ buildable area
— new roads	■ existing park	--- new right of way alignment
— existing roads	■ potential open space	--- new right of way edge
- - - existing properties	■ potential civic space	■ flexible road alignment



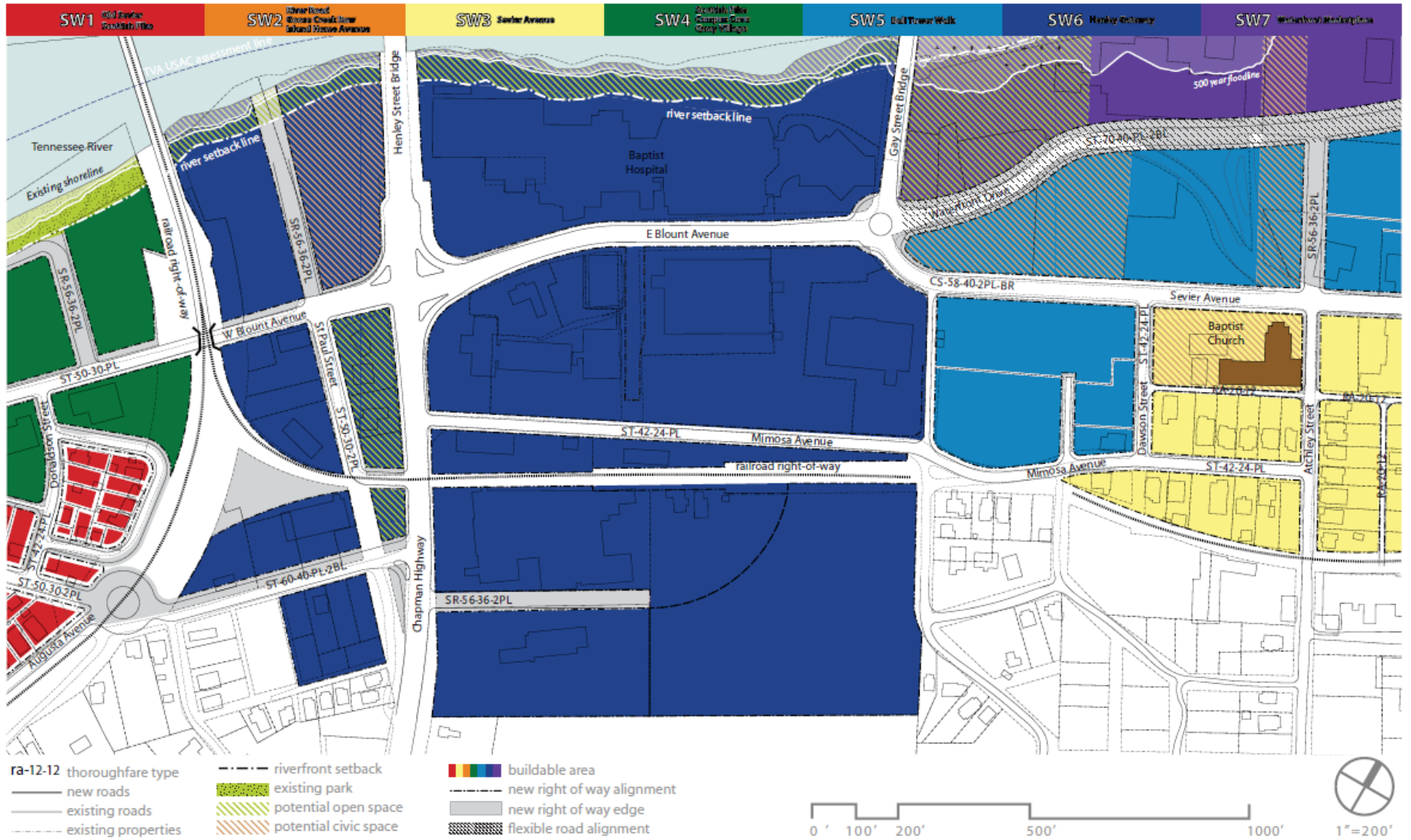

REGULATING PLAN

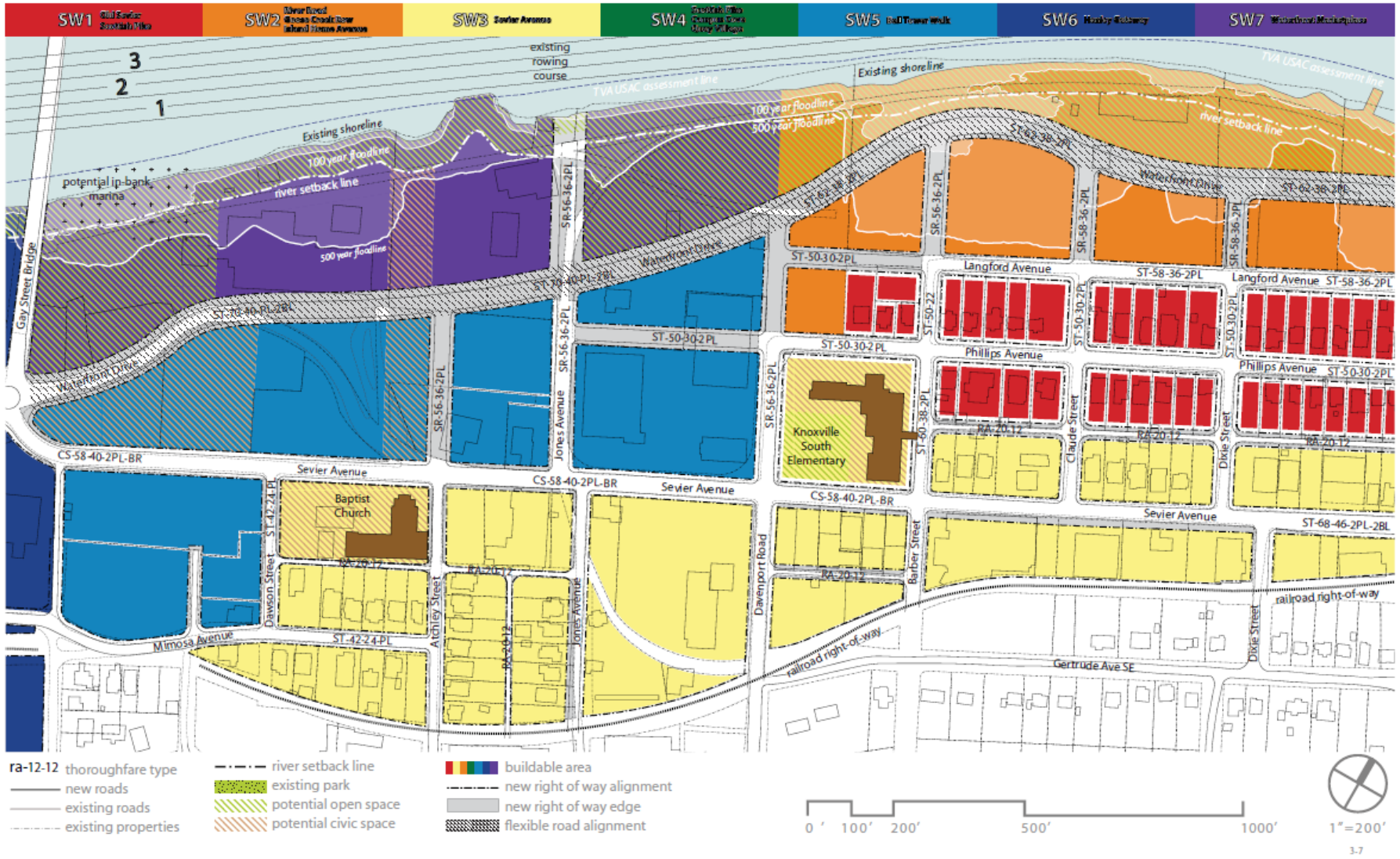

REGULATING PLAN

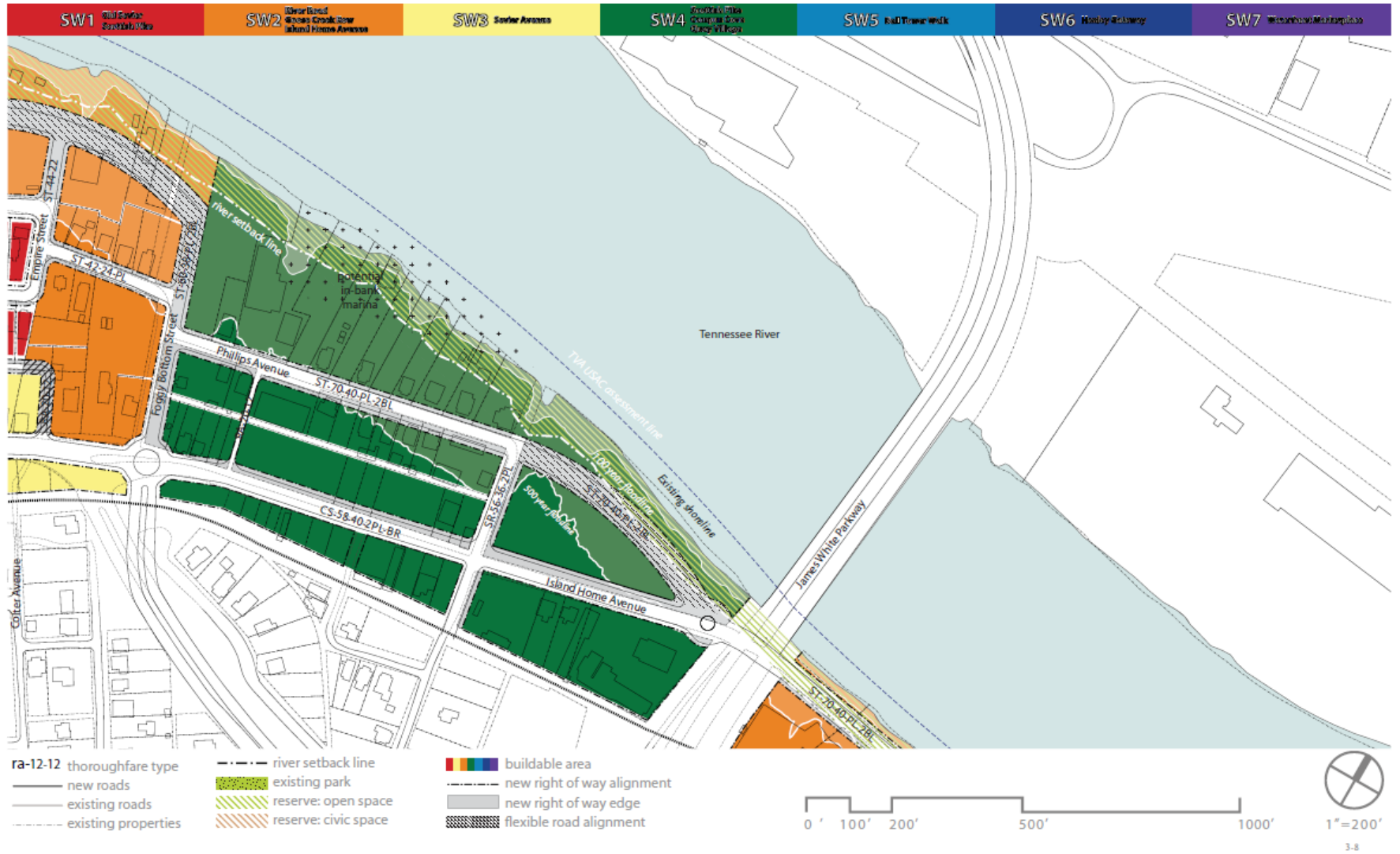

Regulating Plan | 4.1.2. Vision Plan & Regulating Plan

South Waterfront District (SW-1) Knoxville, Tennessee

REGULATING PLAN

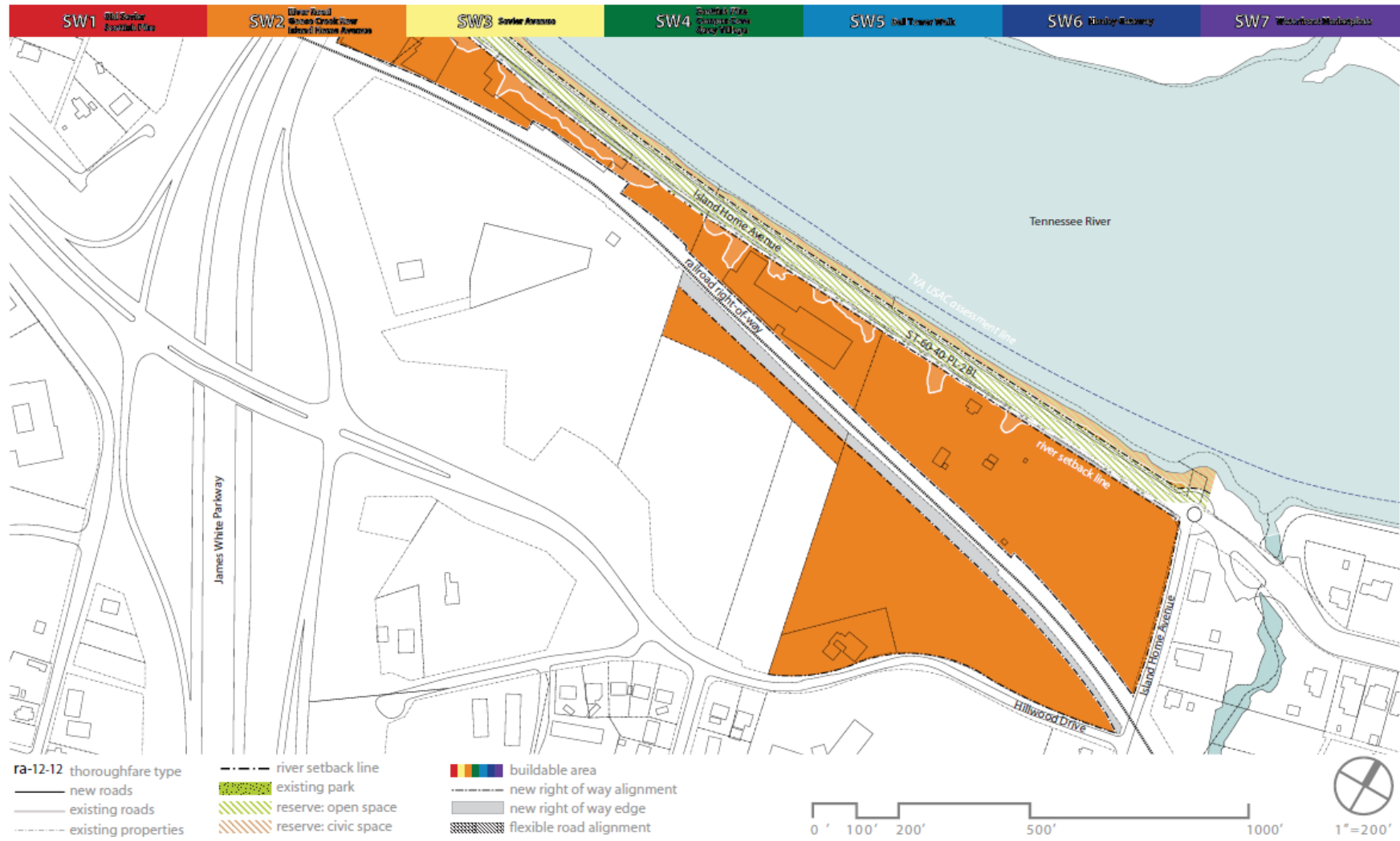

This Page Left Intentionally Blank

4.1.3. Property Development Standards by District

A. Check List

	Complies	Complies with Administrative Deviation	Does not Comply	N/A
VISION & INTENT				
Statement	<input type="checkbox"/>	<input type="checkbox"/>	<input type="checkbox"/>	<input type="checkbox"/>
DEVELOPMENT STANDARDS				
Existing Conditions				
Topography	<input type="checkbox"/>	<input type="checkbox"/>	<input type="checkbox"/>	<input type="checkbox"/>
Existing Trees	<input type="checkbox"/>	<input type="checkbox"/>	<input type="checkbox"/>	<input type="checkbox"/>
100-Year Flood Lines	<input type="checkbox"/>	<input type="checkbox"/>	<input type="checkbox"/>	<input type="checkbox"/>
500-Year Flood Lines	<input type="checkbox"/>	<input type="checkbox"/>	<input type="checkbox"/>	<input type="checkbox"/>
Environmental & Archeological	<input type="checkbox"/>	<input type="checkbox"/>	<input type="checkbox"/>	<input type="checkbox"/>
Block Layout				
Block Size	<input type="checkbox"/>	<input type="checkbox"/>	<input type="checkbox"/>	<input type="checkbox"/>
Building Lines:				
River Buffer Setback	<input type="checkbox"/>	<input type="checkbox"/>	<input type="checkbox"/>	<input type="checkbox"/>
Stream Buffer Setback	<input type="checkbox"/>	<input type="checkbox"/>	<input type="checkbox"/>	<input type="checkbox"/>
Proposed Subdivision & Phasing	<input type="checkbox"/>	<input type="checkbox"/>	<input type="checkbox"/>	<input type="checkbox"/>
Buildings Siting & Configuration				
Principal Building Siting:				
Orientation	<input type="checkbox"/>	<input type="checkbox"/>	<input type="checkbox"/>	<input type="checkbox"/>
Front Setback	<input type="checkbox"/>	<input type="checkbox"/>	<input type="checkbox"/>	<input type="checkbox"/>
Frontage at Setback	<input type="checkbox"/>	<input type="checkbox"/>	<input type="checkbox"/>	<input type="checkbox"/>
Side Setback	<input type="checkbox"/>	<input type="checkbox"/>	<input type="checkbox"/>	<input type="checkbox"/>
Rear Setback	<input type="checkbox"/>	<input type="checkbox"/>	<input type="checkbox"/>	<input type="checkbox"/>
Building Coverage	<input type="checkbox"/>	<input type="checkbox"/>	<input type="checkbox"/>	<input type="checkbox"/>
Lot Size	<input type="checkbox"/>	<input type="checkbox"/>	<input type="checkbox"/>	<input type="checkbox"/>
Open Space Coverage	<input type="checkbox"/>	<input type="checkbox"/>	<input type="checkbox"/>	<input type="checkbox"/>
Principal Building Configuration				
Building Width	<input type="checkbox"/>	<input type="checkbox"/>	<input type="checkbox"/>	<input type="checkbox"/>
Building Height Min	<input type="checkbox"/>	<input type="checkbox"/>	<input type="checkbox"/>	<input type="checkbox"/>
Building Height Max	<input type="checkbox"/>	<input type="checkbox"/>	<input type="checkbox"/>	<input type="checkbox"/>
Footprint / Floor Plate	<input type="checkbox"/>	<input type="checkbox"/>	<input type="checkbox"/>	<input type="checkbox"/>
Floor Area Ratio (FAR)	<input type="checkbox"/>	<input type="checkbox"/>	<input type="checkbox"/>	<input type="checkbox"/>
Ancillary Structures & Outdoor Spaces				
Ancillary / Accessory Structures	<input type="checkbox"/>	<input type="checkbox"/>	<input type="checkbox"/>	<input type="checkbox"/>
Ancillary Structure Envelope:				
Footprint / Floor Plate	<input type="checkbox"/>	<input type="checkbox"/>	<input type="checkbox"/>	<input type="checkbox"/>
Front Setback	<input type="checkbox"/>	<input type="checkbox"/>	<input type="checkbox"/>	<input type="checkbox"/>
Side Setback	<input type="checkbox"/>	<input type="checkbox"/>	<input type="checkbox"/>	<input type="checkbox"/>
Rear Setback	<input type="checkbox"/>	<input type="checkbox"/>	<input type="checkbox"/>	<input type="checkbox"/>
Building Height	<input type="checkbox"/>	<input type="checkbox"/>	<input type="checkbox"/>	<input type="checkbox"/>
Outdoor Space Types	<input type="checkbox"/>	<input type="checkbox"/>	<input type="checkbox"/>	<input type="checkbox"/>
Usable Private Outdoor Area	<input type="checkbox"/>	<input type="checkbox"/>	<input type="checkbox"/>	<input type="checkbox"/>

	Complies	Complies with Administrative Deviation	Does not Comply	N/A
Building Frontages				
Building Frontages	<input type="checkbox"/>	<input type="checkbox"/>	<input type="checkbox"/>	<input type="checkbox"/>
Building Entries	<input type="checkbox"/>	<input type="checkbox"/>	<input type="checkbox"/>	<input type="checkbox"/>
Building Envelope Articulation:				
Ground Level	<input type="checkbox"/>	<input type="checkbox"/>	<input type="checkbox"/>	<input type="checkbox"/>
Façade Length	<input type="checkbox"/>	<input type="checkbox"/>	<input type="checkbox"/>	<input type="checkbox"/>
Façade Openings	<input type="checkbox"/>	<input type="checkbox"/>	<input type="checkbox"/>	<input type="checkbox"/>
Roofs	<input type="checkbox"/>	<input type="checkbox"/>	<input type="checkbox"/>	<input type="checkbox"/>
Other	<input type="checkbox"/>	<input type="checkbox"/>	<input type="checkbox"/>	<input type="checkbox"/>
Building Function	<input type="checkbox"/>	<input type="checkbox"/>	<input type="checkbox"/>	<input type="checkbox"/>
Off Street Parking & Loading				
Parking Types	<input type="checkbox"/>	<input type="checkbox"/>	<input type="checkbox"/>	<input type="checkbox"/>
Parking Spaces, Reserved & Shared	<input type="checkbox"/>	<input type="checkbox"/>	<input type="checkbox"/>	<input type="checkbox"/>
Pavements	<input type="checkbox"/>	<input type="checkbox"/>	<input type="checkbox"/>	<input type="checkbox"/>
Garage Location	<input type="checkbox"/>	<input type="checkbox"/>	<input type="checkbox"/>	<input type="checkbox"/>
Screening & Shading	<input type="checkbox"/>	<input type="checkbox"/>	<input type="checkbox"/>	<input type="checkbox"/>
Accessible Spaces & Routes	<input type="checkbox"/>	<input type="checkbox"/>	<input type="checkbox"/>	<input type="checkbox"/>
Driveways & Curb Cuts	<input type="checkbox"/>	<input type="checkbox"/>	<input type="checkbox"/>	<input type="checkbox"/>
Garage Entry	<input type="checkbox"/>	<input type="checkbox"/>	<input type="checkbox"/>	<input type="checkbox"/>
Service Loading	<input type="checkbox"/>	<input type="checkbox"/>	<input type="checkbox"/>	<input type="checkbox"/>
Bicycle Parking	<input type="checkbox"/>	<input type="checkbox"/>	<input type="checkbox"/>	<input type="checkbox"/>
External Elements				
Proposed Topography Grades	<input type="checkbox"/>	<input type="checkbox"/>	<input type="checkbox"/>	<input type="checkbox"/>
Side or Rear Privacy Fence or Wall	<input type="checkbox"/>	<input type="checkbox"/>	<input type="checkbox"/>	<input type="checkbox"/>
Front Fence or Wall	<input type="checkbox"/>	<input type="checkbox"/>	<input type="checkbox"/>	<input type="checkbox"/>
Landscaped Vegetation				
Trees	<input type="checkbox"/>	<input type="checkbox"/>	<input type="checkbox"/>	<input type="checkbox"/>
Shrubs & Groundcover	<input type="checkbox"/>	<input type="checkbox"/>	<input type="checkbox"/>	<input type="checkbox"/>
Slopes	<input type="checkbox"/>	<input type="checkbox"/>	<input type="checkbox"/>	<input type="checkbox"/>
Trash Storage & Recycling	<input type="checkbox"/>	<input type="checkbox"/>	<input type="checkbox"/>	<input type="checkbox"/>
External Mechanical & Electrical Units	<input type="checkbox"/>	<input type="checkbox"/>	<input type="checkbox"/>	<input type="checkbox"/>
Signs	<input type="checkbox"/>	<input type="checkbox"/>	<input type="checkbox"/>	<input type="checkbox"/>
Lighting Trespass	<input type="checkbox"/>	<input type="checkbox"/>	<input type="checkbox"/>	<input type="checkbox"/>
Stormwater Systems				
Piped Roof Water	<input type="checkbox"/>	<input type="checkbox"/>	<input type="checkbox"/>	<input type="checkbox"/>
Ground Surface Runoff in Areas with Subsoil	<input type="checkbox"/>	<input type="checkbox"/>	<input type="checkbox"/>	<input type="checkbox"/>
Ground Surface Runoff in Areas of Rock and/or Contamination	<input type="checkbox"/>	<input type="checkbox"/>	<input type="checkbox"/>	<input type="checkbox"/>
Sustainability				
Green Building & Landscape	<input type="checkbox"/>	<input type="checkbox"/>	<input type="checkbox"/>	<input type="checkbox"/>
Reflectivity	<input type="checkbox"/>	<input type="checkbox"/>	<input type="checkbox"/>	<input type="checkbox"/>

B. SW1 Old Sevier and Scottish Pike



1. Vision and Intent

The Old Sevier and Scottish Pike areas are envisioned to conserve the “small town, neighborhood” atmosphere. New developments in these areas are encouraged to preserve and extend the existing neighborhood character and to maintain a complementary scale and density. Large-scale assemblage of residential properties or any commercial uses are prohibited. Suggested building types include detached houses, cottages, duplex houses, attached townhouses and rowhouses.

New street alignments in combination with the existing roads define important access and view corridors to the river and the bluffs. The completed road network establishes a “figure eight” loop by adding a new rail underpass to connect to August Avenue en route to Vestal. The road network links Blount Avenue to the new Waterfront Drive (east of the Gay Street Bridge) then to Sevier Avenue and Augusta Avenue. In order to alleviate Blount Avenue from congestion associated with new development, improvements to Augusta Avenue change the character of this street from a tertiary street to a significant boulevard with a bus route and close relationship to the rail line. Scottish Pike will enjoy new access to Fort Dickerson Park and a newly landscaped green corridor of Goose Creek. Proposed street right-of-ways improve pedestrian circulation as well as integrate street trees.

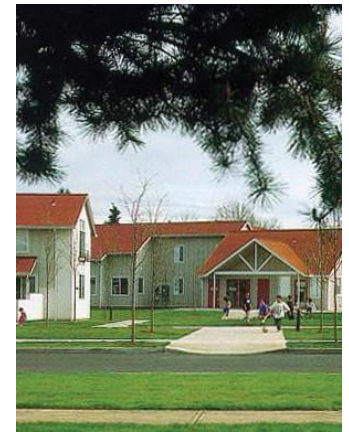

2. Existing Conditions

a. Intent

Guide site survey to assess existing site conditions for constraints and opportunities. Maintain views to river and downtown when viewed from hills behind.

b. Topography

Consider existing topography and provide topographic survey with 2 foot contours.

c. Existing Trees

- i. Identify all existing trees with a 6 inch minimum caliper including root zone within dripline.
- ii. Preserve a minimum of 1 healthy large canopy tree per lot, or 6 healthy trees per acre, whichever is greater.

~~d. 100-Year Flood Lines~~

- ~~i. Preserve Goose Creek TVA flowage easement at 822.~~
- ~~ii. No fill or study to show "no rise" certification.~~

~~e. 500-Year Flood Lines~~

~~Lowest habitable floor elevation is EL 828.8.~~

f. Environmental and Archaeological

- i. Comply with State and Federal requirements.
- ~~ii. Report on environmental and/or archaeological findings.~~

3. Block Layout

a. Intent

Guide lot layout and outline the maximum block perimeter and building setbacks permitted in this district to ensure walkable neighborhoods.

b. Block Size

Maximum perimeter of 1,400 feet.

c. Building Lines

- i. Minimum of 70 feet from normal pool EL 813.0. Refer to Sec. 4.1.6, Riverscape Standards.
- ~~ii. Minimum of 50 feet from stream centerline.~~

d. Proposed Subdivision and Phasing Plan

Clearly designate future phases and describe proposed subdivision plan and phasing when applicable.

4. Building Siting and Configuration

Intent: Provide building configuration and design parameters.

Axonometric Diagram

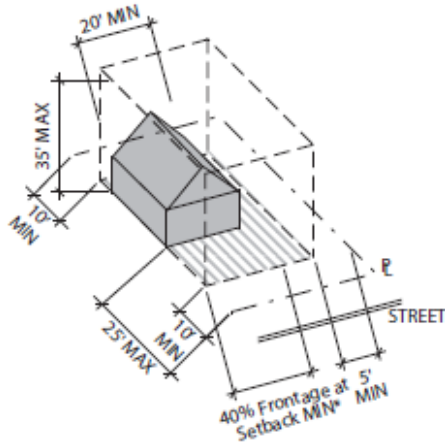

Section Siting

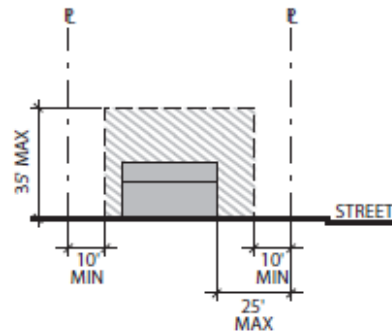

Plan Width and Siting

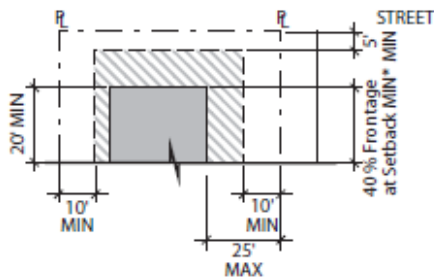

Definitions

- Maximum building outline
 - Minimum building outline
 - = Property line
- *Frontage requirements do not apply to single family or duplex residences

Principal Building Siting	
Orientation	NA
Front Setback (min/max)	10'/25'
Frontage at Setback (min)	40% (excluding single-family or duplexes)
Side Setback (min)	5'
Rear Setback (min)	10'
Lot Size (max)	15,000 SF
Building Coverage (max)	30% (including accessory structures)
Open Space Coverage (min)	70%

Principal Building Configuration	
Building Width (min)	20'
Building Height (min)	NA
Building Height (max)	35' & 2.5 Stories
Footprint / Floor Plate	NA
Floor Area Ratio (max)	1

5. Ancillary Structures and Outdoor Spaces

Intent: Provide outdoor space configuration and design parameters.

Axonometric Diagram

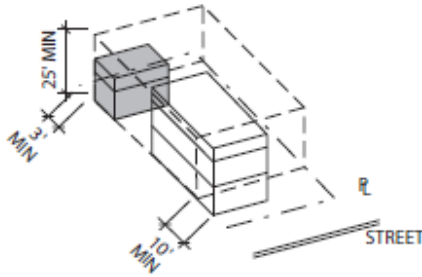

Section Height and Siting

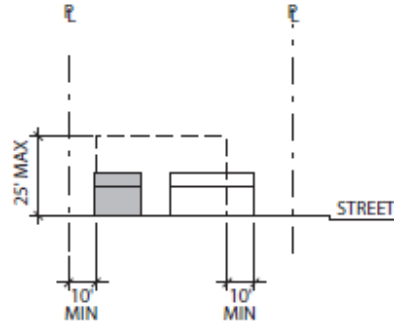

Plan Siting

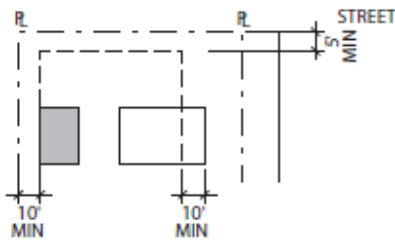

Definitions

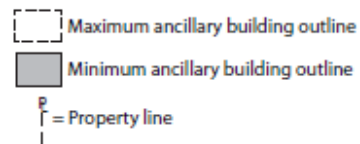

Ancillary/Accessory Structures	
Rear studio, detached garage, workshop, live/work unit, accessory dwelling unit, gazebo, garden shed	
Ancillary/Accessory Structure Envelope	
Footprint/Floor Plate (max)	650 SF
Front Setback	10' + Building Setback
Frontage at Setback	NA
Side Setback (min)	5'
Rear Setback (min)	10'
Building Width	NA
Building Height (max)	25' and 2 Story

Outdoor Space Types
Front yard, side yard, rear yard, gardens
Usable Private Open Space
400 SF (min)

6. Building Frontages

Frontage Typologies: Refer to Sec. 4.1.4.C.

Definitions

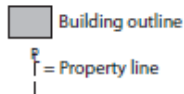

Common Yard

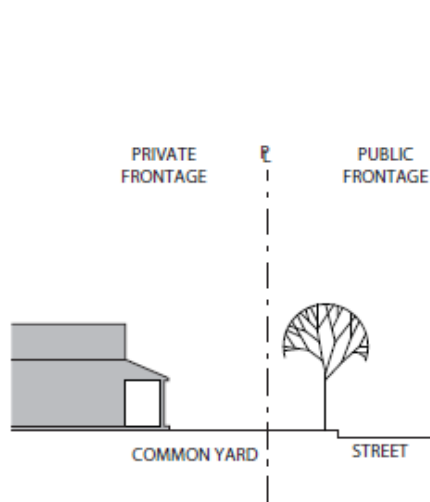

Stoop

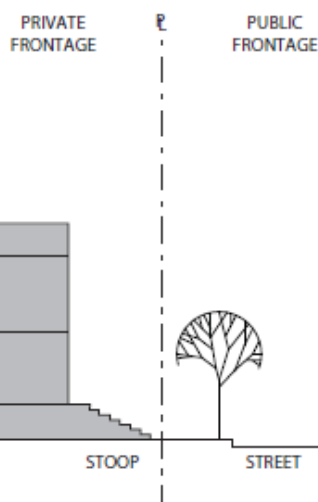

Porch

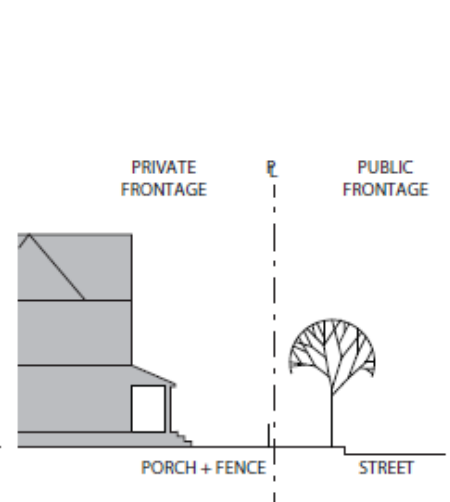

Building Entries	
Primary entry on principal frontage	
Building Envelope Articulation	
Ground Level	NA
Facade Length	NA
Facade Openings	Openings on the principal frontage shall be min 25% of the building wall area
Roofs	Buildings may have flat or sloped roofs
Other	Balconies, porches, bay windows and other projections are encouraged and may be incorporated into the building setback

Building Function
Household Living
Places of Worship, Schools and Day cares may be considered on a use on review basis

7. Off Street Parking and Loading

Intent: Provide with adequate parking to accommodate the district's various building types and functions. Refer to Sec. 4.1.4.D.

Axonometric Diagram

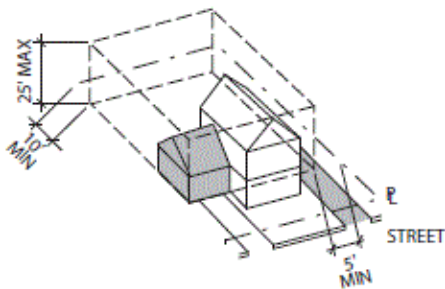

Section Height and Siting

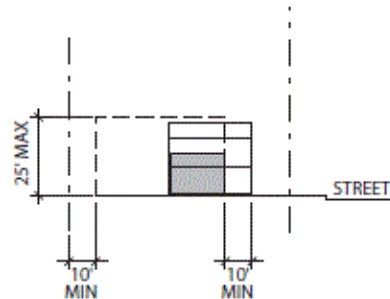

Plan Siting

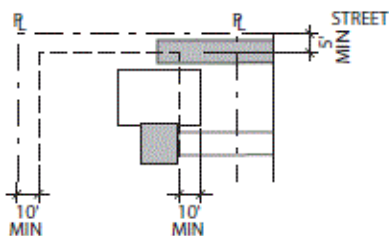

Definitions

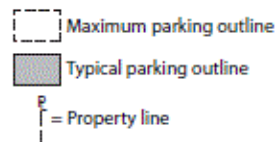

a. Parking Types

Surface or Garage.

b. Parking Spaces, Reserved and Shared

Minimum of 1 parking space per unit; Maximum of 2 parking spaces per unit.

c. Pavements

65% minimum of uncovered **surface parking** vehicular pavements shall be **permeable porous** (a minimum of 8% openings) while meeting overall stormwater requirements.

d. Garage Location

Setback 10 feet further than building.

e. Screening and Shading

One tree (with a 2 inch minimum caliper) is required for every 5 surface parking spaces, to be planted in a minimum 5 foot wide vegetated islands and/or medians.

f. Accessible Spaces and Routes

Meet or exceed city accessibility standards.

g. Driveways and Curb Cuts

i. One on any frontage with a ~~40~~ **15** foot maximum for one way traffic and ~~24~~ **26** foot maximum for two way traffic.

ii. Sidewalk materials and patterning is continuous through driveway.

h. Garage Entry

One on any frontage.

i. Service Loading

Not permitted.

j. Bicycle Parking

Not required - NA to single family residential.

8. External Elements

a. Intent

Guide the integration of external elements into property development including landscaping, utilities and lighting. Refer to Sec. 4.1.4.E, Signage and Sec. 4.1.4.F, Lighting and Noise.

b. Proposed Topography Grades

Provide grading plan with 2 foot contours.

c. Side or Rear Privacy Fence or Wall

Maximum of 8 feet.

d. Front Fence Or Wall

Maximum of 3 feet 6 inches in front yard or streetside of corner lot.

e. Landscape Vegetation

- i. Minimum of 8 trees (with a 2 inch minimum caliper) per acre of area not covered by buildings.
- ii. Trees required for surface parking may be counted **toward overall landscape requirement.**
- iii. ~~Maximize shrubs and groundcover per acre of area not covered by buildings.~~

f. ~~Slopes~~

~~Complete ground cover on slopes steeper than 3:1 for erosion control.~~

g f. Trash Storage/Recycling, External Mechanical Units, Electrical Units, and Rain Barrels

Integrate with building design or screen / conceal from view from public street and riverwalk.

~~h. External Mechanical Units, Electrical Units and Rain Barrels~~

~~Integrate with building design or screen / conceal from view from public street and riverwalk with no encroachment into setback area.~~

i g. Signage

House number.

j. ~~Lighting Trespass~~

- i. ~~Pre-Curfew Limitations for Environmental Zone E2.~~
- ii. ~~As Defined by Illuminating Engineers Society of Lighting for Exterior Environment RP-33.~~

~~9. Stormwater Systems~~

~~a. Intent~~

~~Improve water quality in streams and river by reducing stormwater runoff volume, temperature and velocity.~~

~~b. Piped Roof Water~~

~~If a closed drainage system, then no treatment necessary.~~

~~c. Ground Surface Runoff In Areas With Subsoil~~

~~Detain first 0.5 inch rain and percolate into ground, or release within 24 hour minimum and 72 hour maximum.~~

~~d. Ground Surface Runoff In Areas Of Rock and/or Contamination~~

~~Detain first 0.5 inch rain and treat in a stormwater quality structure before discharging to a closed drainage system.~~

40 9. Sustainability

a. Intent

Encourage longevity, durability, energy and economic efficiency as well as improved environmental conditions.

b. Green Building and Landscape

- i. Capable of attaining the **current** Leadership in Energy and Environmental Design (LEED) minimal Performance Level of "Certified."
- ii. Submit completed worksheet of appropriate LEED standard to demonstrate pre-certification estimate.

c. Reflectivity, Heat Island Reduction, Roof and Surface Lots

- i. **Surface lots shall** provide shade and/or use light-colored/high albedo materials with a **solar** reflectance of at least 0.3 **(30%).**
- ii. Roofs shall use an Energy Star Compliant (highly reflective) and **high emissivity roofing** (emissivity of at least 0.9) for a minimum of 75% of the roof surface.

C. SW2 River Rd, Goose Creek Row and Island Home Ave

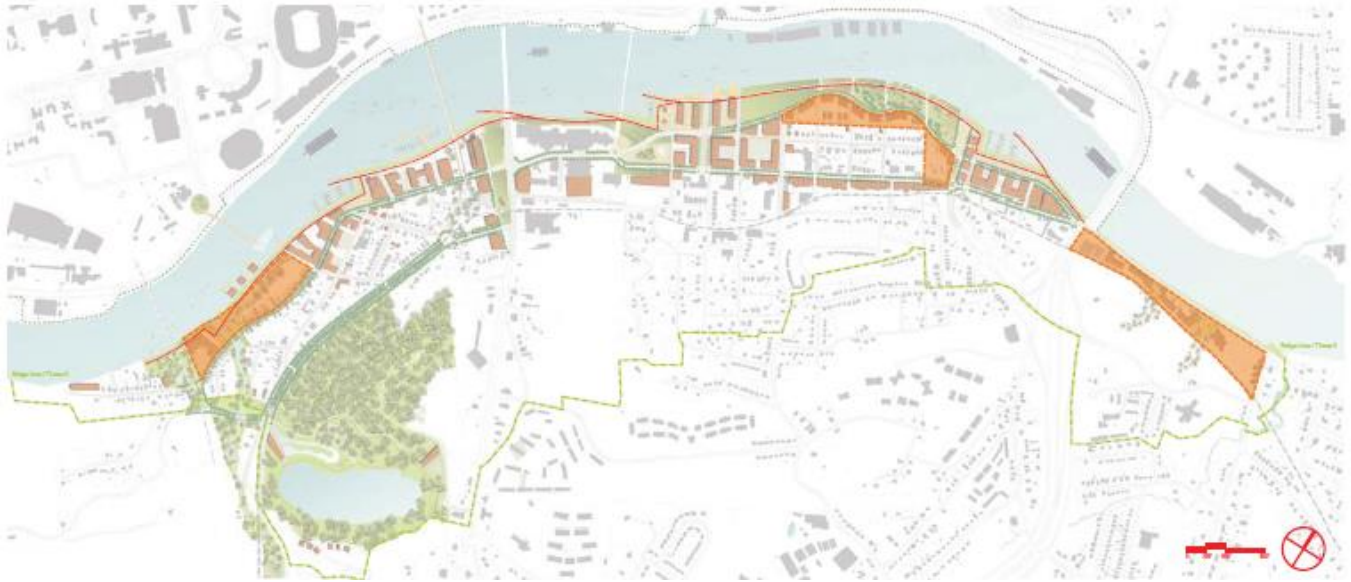

1. Vision and Intent

The neighborhoods of Goose Creek, Waterfront Drive and Island Home Avenue are envisioned to have new, predominantly residential developments along the waterfront that will create a contemporary identity for the Knoxville South Waterfront. Suggested building types include duplex houses, townhouses, rowhouses and multiple unit housing. With a newly landscaped shoreline experience and a continuous riverfront setback along the river's edge, these developments provide residents spectacular vistas of the river but minimize obstructed views perpendicular to the river. The proposed River Street will be layered with modes of two-direction travel - bike lanes, on-street parking, a wide sidewalk and a well-landscaped river walk. River Street will be an important part of the "figure eight" road network making a loop from Gay Street to Sevier and Phillips Avenues.

A continuous promenade forms the northern edge of the river arboretum – the major open space of the area located in the flood plain. Residents enjoy access to a wealth of waterfront and water-based recreational activities. While these neighborhoods are primarily residential, they are located adjacent to highly-accessed public parks that boast many visitors on a daily basis and during city-wide events. Residents have access to the newly landscaped Goose Creek Green Corridor with a direct link to Fort Dickerson Quarry. Public access to the river is created along axes following the north-south streets, while on-street parking accommodates visitors to the parks and various recreational facilities. A bridge connection to the University may link the two sides of the river.



2. Existing Conditions

a. Intent

Guide site survey to assess existing site conditions for constraints and opportunities. Direct views to river and downtown, when viewed from neighborhoods behind.

b. Topography

Consider existing topography and provide topographic survey with 2 foot contours.

c. Existing Trees

- i. Identify all existing trees with a 6 inch minimum caliper including root zone within dripline.
- ii. Preserve a minimum of 1 healthy large canopy tree per lot, or 6 healthy trees per acre, whichever is greater.

~~d. 100-Year Flood Lines~~

- ~~i. Tennessee River 100-Year flood line is EL 821.5.~~
- ~~ii. Preserve Goose Creek TVA flowage easement at 822.~~
- ~~iii. No fill or study to show "no rise" certification.~~

~~e. 500-Year Flood Lines~~

~~Lowest habitable floor elevation is EL 828.8.~~

~~f d. Environmental and Archaeological~~

- ~~i. Comply with State and Federal Requirements.~~
- ~~ii. Report on environmental and/or archaeological findings.~~

3. Block Layout

a. Intent

Guide lot layout and outline the maximum block perimeter and building setbacks permitted in this district to ensure walkable neighborhoods.

b. Block Size

Maximum perimeter of 1,400 feet.

c. Building Lines

- ~~i. Minimum of 70 feet from normal pool EL 813.0. Refer to Sec. 4.1.6, Riverscape Standards.~~
- ~~ii. Minimum of 50 feet from stream centerline.~~

d. Proposed Subdivision and Phasing Plan

Clearly designate future phases and describe proposed subdivision plan and phasing when applicable.

4. Building Siting and Configuration

Intent: Provide building configuration and design parameters, as well as suggestions for building function.

Axonometric Diagram

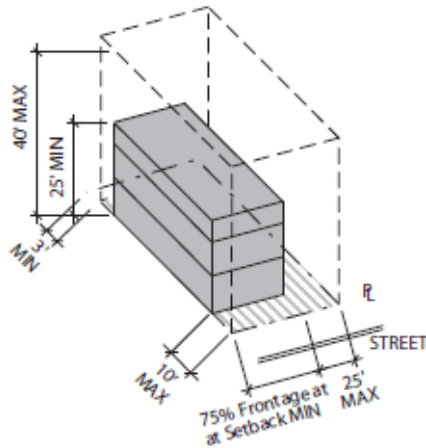

Section Height and Siting

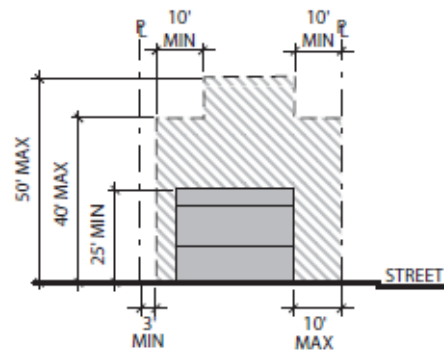

Plan Width and Siting

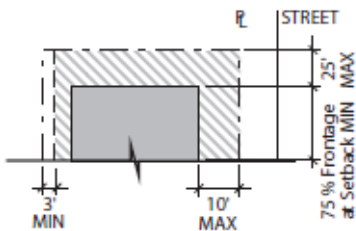

Definitions

- Maximum building outline
- Minimum building outline
- = Property line

Principal Building Siting	
Orientation	NA
Front Setback (max)	10'
Frontage at Setback (min)	75%
Side Setback (max)	25'
Rear Setback (min)	3'
Lot Size (max)	3 acres
Building Coverage (max)	70%
Open Space Coverage (min)	30%

Principal Building Configuration	
Building Height (min)	25' & 2 Story
Building Height (max)	40' & 3 Stories plus 10' and 1 Story max at Setback + 10'
Footprint / Floor Plate	NA
Floor Area Ratio (max)	3

5. Ancillary Structures and Outdoor Spaces

Intent: Provide outdoor space configuration and design parameters.

Axonometric Diagram

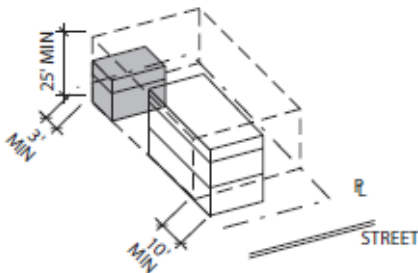

Section Height and Siting

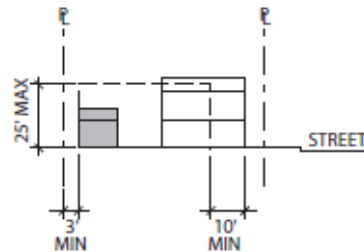

Plan Siting

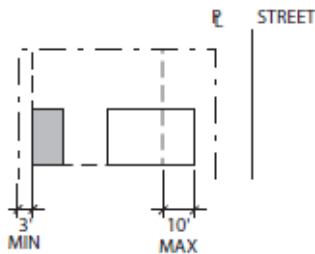

Definitions

- Maximum ancillary building outline
- Minimum ancillary building outline
- = Property line

Ancillary/Accessory Structures

Rear studio, detached garage, workshop, live/work unit, accessory dwelling unit, gazebo, garden shed

Ancillary/Accessory Structure Envelope

Footprint/Floor Plate (max)	650 SF
Front Setback	10' + Building Setback
Frontage at Setback	NA
Side Setback	NA
Rear Setback (min)	3'
Building Width	NA
Building Height (max)	25' and 2 Story

Outdoor Space Types

Front yard, side yard, rear yard, roof decks, terraces, sport courts

Usable Private Open Space

400 SF (min)

6. Building Frontages

Frontage Typologies: Refer to Sec. 4.1.4.C.

Definitions

 Building outline

Porch

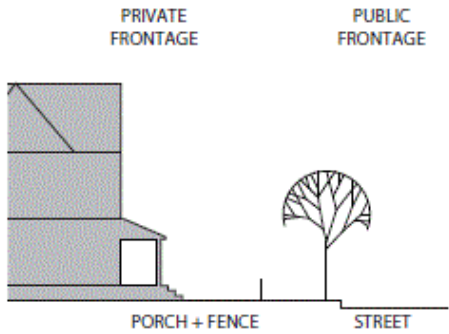

Stoop

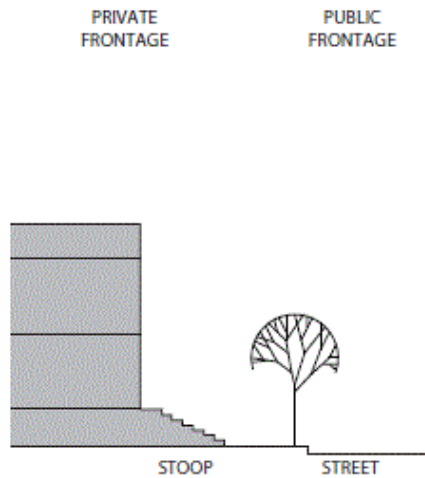

Storefront

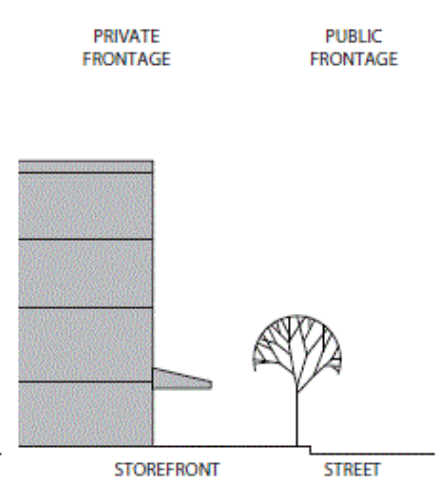

Building Entries

Primary entry on principal frontage

Building Envelope Articulation

Ground Level	NA
Facade Length	Facades longer than 30' shall be divided in a vertically distinguishable manner
Facade Openings	Openings on the principal frontage shall be min 25% of the building wall area
Roofs	Buildings may have flat or sloped roofs
Other	Balconies, porches, bay windows and other projections are encouraged and may be incorporated into the building setback

7. Off Street Parking and Loading

Intent: Provide with adequate parking to accommodate the district's various building types and functions. Refer to Sec. 4.1.4.D.

Axonometric Diagram

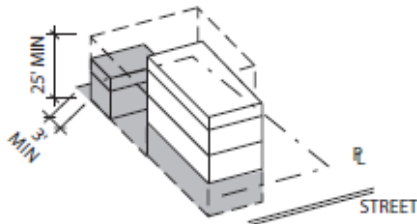

Section Height and Siting

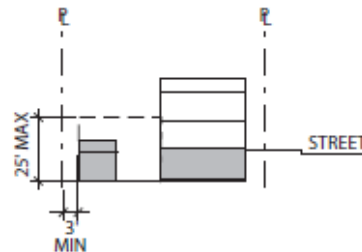

Plan Siting

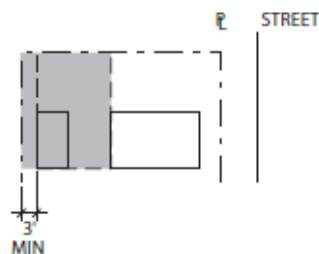

Definitions

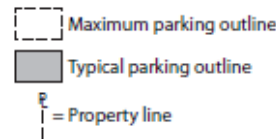

a. Parking Types

Surface lot, garages, under building garage.

b. Parking Spaces, Reserved and Shared

Maximum of 3 parking spaces per 1,000 square feet and maximum of 2 parking spaces per residential unit.

c. Pavements

65% minimum of uncovered **surface parking vehicular pavements** shall be **permeable porous** (a minimum of 8% openings) while meeting overall stormwater requirements.

d. Garage Location

To rear of property or underneath building.

e. Screening and Shading

One tree (with a 2 inch minimum caliper) is required for every 5 surface parking spaces, ~~to be planted in a minimum 5 foot wide vegetated islands and/or medians.~~

f. Accessible Spaces and Routes

Meet or exceed city accessibility standards.

g. Driveways and Curb Cuts

- i. Not permitted on principal frontage and shall be ~~40~~ **15** foot maximum for one way traffic and ~~24~~ **26** foot maximum for two way traffic.
- ii. Sidewalk materials and patterning is continuous through driveway.

h. Garage Entry

From rear alley or side street.

i. Service Loading

Permitted from rear alley or side street.

j. Bicycle Parking

Required. ~~Yes.~~

8. External Elements

Intent: Guide the integration of external elements into property development including landscaping, utilities and lighting. Refer to Sec. 4.1.4.E, Signage and Sec. 4.1.4.F, Lighting and Noise.

Storefront Signage



a. Proposed Topography Grades

Provide grading plan with 2 foot contours.

b. Side or Rear Privacy Fence or Wall

Maximum of 8 feet.

c. Front Fence Or Wall

Maximum of 3 feet 6 inches.

d. Landscape Vegetation

- i. Minimum of 8 trees (with a 2 inch minimum caliper) per acre of open space.
- ii. Trees required for surface parking may be counted **toward overall landscape requirement**.
- iii. ~~Maximize shrubs and groundcover per open space.~~

e. ~~Slopes~~

~~Plant slopes steeper than 3:1 for erosion control.~~

f e. Trash Storage/Recycling, **External Mechanical Units, Electrical Units, and Rain Barrels**

Integrate with building design or screen / conceal from view from public street and riverwalk.

~~g. External Mechanical Units, Electrical Units and Rain Barrels~~

~~Integrate with building design or screen / conceal from view from public street and riverwalk with no encroachment into setback area.~~

~~h. Signage~~

~~External band above entry, hanging or blade sign, awning or overhang.~~

~~i. Lighting Trespass~~

- ~~i. Pre-Curfew Limitations for Environmental Zone E2.~~
- ~~ii. As Defined by Illuminating Engineers Society of Lighting for Exterior Environment RP-33.~~

~~9. Stormwater Systems~~

~~a. Intent~~

~~Improve water quality in streams and river by reducing stormwater runoff volume, temperature and velocity.~~

~~b. Piped Roof Water~~

~~If a closed drainage system, then no treatment necessary.~~

~~c. Ground Surface Runoff In Areas With Subsoil~~

~~Detain first 0.5 inch rain and percolate into ground, or release within 24 hour minimum and 72 hour maximum.~~

~~d. Ground Surface Runoff In Areas Of Rock and/or Contamination~~

~~Detain first 0.5 inch rain and treat in a stormwater quality structure before discharging to a closed drainage system.~~

9. Sustainability

a. Intent

Encourage longevity, durability, energy and economic efficiency as well as improved environmental conditions.

b. Green Building and Landscape

- i. Capable of attaining the **current** Leadership in Energy and Environmental Design (LEED) minimal Performance Level of "Certified."
- ii. Submit completed worksheet of appropriate LEED standard to demonstrate pre-certification estimate.

c. Reflectivity, Heat Island Reduction, Roof and Surface Lots

- i. **Surface lots shall** provide shade and/or use light-colored/high albedo materials with a **solar** reflectance of at least 0.3 (**30%**).
- ii. Roofs shall use an Energy Star Compliant (highly reflective) and high emissivity roofing (**emissivity of at least 0.9**) for a minimum of 75% of the roof surface.

D. SW3 Sevier Avenue

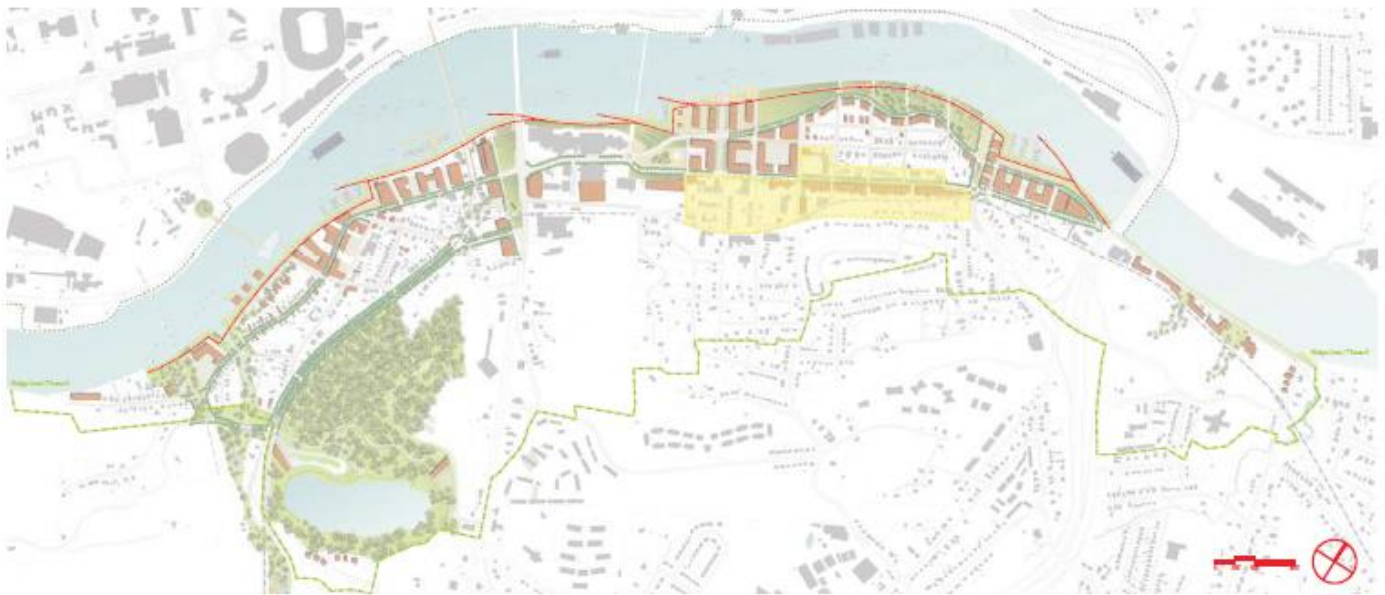

1. Vision and Intent

Sevier Avenue is the historic commercial heart of the Old Sevier neighborhood. It has the potential to fulfill the role of 'Main Street' in the future and become a viable commercial center for the local neighborhoods. New development in this area has a mix of commercial and retail uses on ground floors that promote both daytime and nighttime activities. Developments in this area could also house multiple residential units on the upper floors. The new mixed-use infill development will complement the existing buildings and preserve the historic character that exists. New buildings shall be built up to the street (rather than being setback from the street) to reinforce the continuity of the street wall.

Parking for new developments will be to the rear of the site as well as on-street. Existing historic buildings will be encouraged to be restored for reuse. Suggested building types that may exist in this vibrant district include mixed-use shopfront buildings and loft developments. A potential conversion of the freight rail line to light rail may provide public transportation to the area in the future.



2. Existing Conditions and Block Layout

a. Intent

Guide site survey to assess existing site conditions for constraints and opportunities.

b. Topography

Consider existing topography and provide topographic survey with 2 foot contours.

c. Existing Trees

- i. Identify all existing trees with a 6 inch minimum caliper including root zone within dripline.
- ii. Preserve a minimum of 1 healthy large canopy tree per lot, or 6 healthy trees per acre, whichever is greater.

~~d. 100-Year Flood Lines~~

- ~~i. Tennessee River 100-Year flood line is EL 821.5.~~
- ~~ii. No fill or study to show "no rise" certification.~~

~~e. 500-Year Flood Lines~~

~~Lowest habitable floor elevation is EL 828.8.~~

~~f~~ d. Environmental and Archaeological

- ~~i. Comply with State and Federal Requirements.~~
- ~~ii. Report on environmental and/or archaeological findings.~~

3. Block Layout

a. Intent

Guide lot layout and outline the maximum block perimeter and building setbacks permitted in this district to ensure walkable neighborhoods.

b. Block Size

Maximum perimeter of 1,400 feet.

c. Building Lines

- ~~i. Minimum of 70 feet from normal pool EL 813.0. Refer to Sec. 4.1.6, Riverscape Standards.~~
- ~~ii. Minimum of 50 feet from stream centerline.~~

d. Proposed Subdivision and Phasing Plan

Clearly designate future phases and describe proposed subdivision plan and phasing when applicable.

4. Building Siting and Configuration

Intent: Provide building configuration and design parameters, as well as suggestions for building function.

Axonometric Diagram

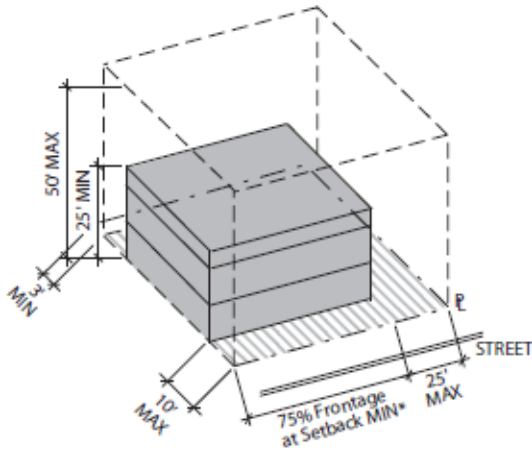

Section Height and Siting

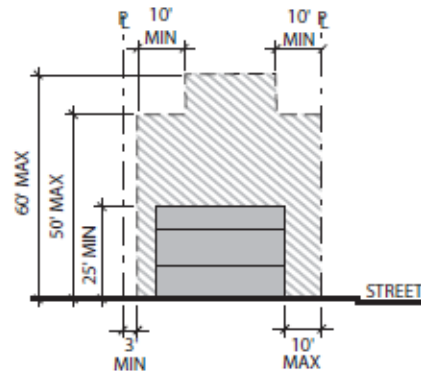

Plan Width and Siting

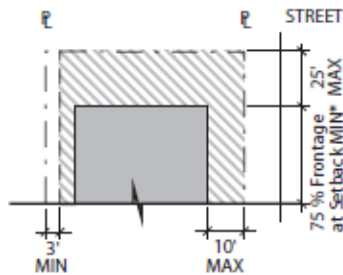

Definitions

- Maximum building outline
- Minimum building outline

= Property line

*75% Frontage at Setback is applicable to Sevier Avenue only. All other streets have a 40% Frontage at Setback MIN requirement.

Principal Building Siting	
Orientation	NA
Front Setback (max)	10'
Frontage at Setback (min)	75% to Sevier Avenue, 40% to all others
Side Setback (max)	25'
Rear Setback (min)	3'
Lot Size (max)	3 acres
Building Coverage (max)	80%
Open Space Coverage (min)	20%

Principal Building Configuration	
Building Width	NA
Building Height (min)	25' & 2 Story
Building Height (max)	50' & 4 Stories plus 10' and 1 Story max at Setback + 10'
Footprint / Floor Plate (max)	30,000 SF; Does not apply to structured parking footprint
Floor Area Ratio (max)	4

5. Ancillary Structures and Outdoor Spaces

a. Intent

Provide outdoor space configuration and design parameters.

b. Ancillary/Accessory Structures

NA

c. Ancillary/Accessory Structure Envelope

i. Footprint/Floor Plate: NA

ii. Front Setback: NA

iii. Frontage at Setback: NA

iv. Side Setback: NA

v. Rear Setback: NA

vi. Building Width: NA

vii. Building Height: NA

d. Outdoor Space Types

Roof decks, patios

e. Usable Private Open Space

NA

6. Building Frontages

Frontage Typologies: Refer to Sec. 4.1.4.C.

Definitions

 Building outline

Storefront

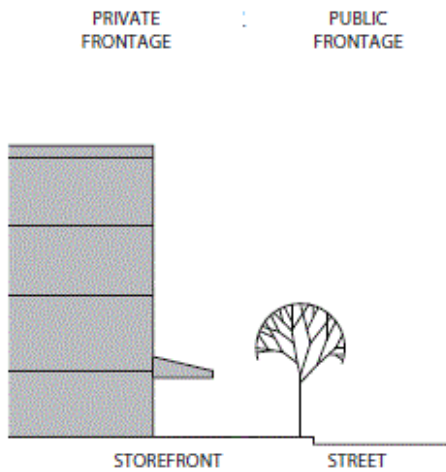

Stoop

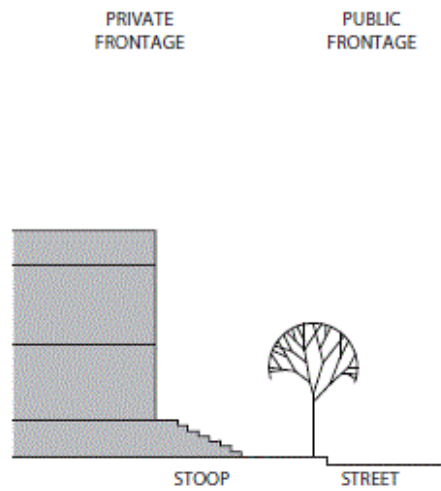

Building Entries
Primary entry on principal frontage

Building Envelope Articulation	
Ground Level	Min 70% transparent glass at the ground level on principal frontage
Facade Length	NA
Facade Openings	Openings above the first story on the principal frontage shall be min 25% of the building wall area
Roofs	Buildings may have flat or sloped roofs
Other	Balconies, porches, bay windows and other projections are encouraged and may be incorporated into the building setback

7. Off Street Parking and Loading

Intent: Provide with adequate parking to accommodate the district's various building types and functions. Refer to Sec. 4.1.4.D.

Structured Parking with Vegetation Buffer

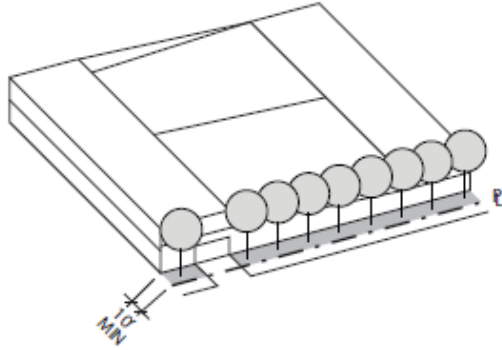

Structured Parking with Building Buffer

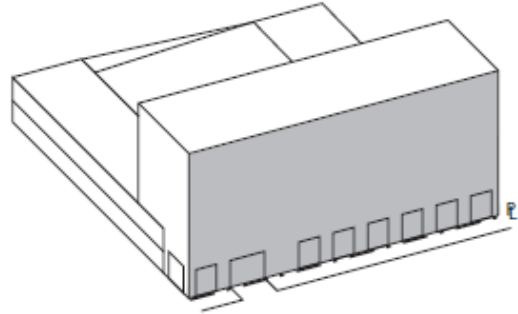

Structured Parking with Screening

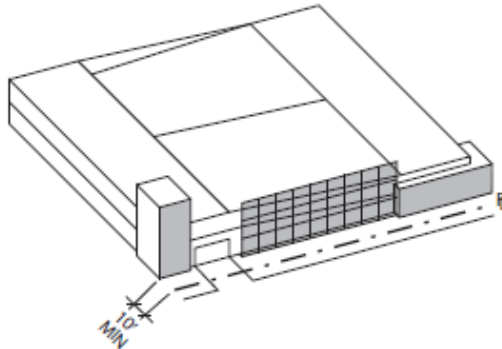

Surface Parking with Vegetation Buffer and Low Wall

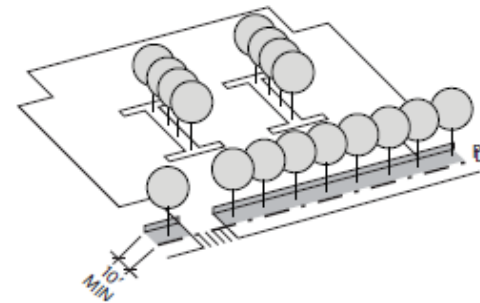

- a. Parking Types
 - Surface lot, above ground structure, basement garage.
- b. Parking Spaces, Reserved and Shared
 - Maximum of 3 parking spaces per 1,000 square feet and maximum of 2 parking spaces per residential unit.
- c. Pavements
 - 65% minimum of uncovered **surface parking vehicular pavements** shall be **permeable porous** (a ~~minimum of 8% openings~~) while meeting overall stormwater requirements.
- d. Garage Location
 - To rear of property or underneath building.
- e. Screening and Shading
 - One tree (with a 2 inch minimum caliper) is required for every 5 surface parking spaces, ~~to be planted in a minimum 5 foot wide vegetated islands and/or medians.~~
- f. Accessible Spaces and Routes
 - Meet or exceed city accessibility standards.
- g. ~~Driveways and Curb Cuts~~
 - i. Driveway shall be ~~40~~ **15** foot maximum for one way traffic and ~~24~~ **26** foot maximum for two way traffic.
 - ii. Sidewalk materials and patterning is continuous through driveway.
- h. Garage Entry
 - Permitted on all frontages.
- i. Service Loading
 - ~~Yes.~~ **Permitted.**
- j. Bicycle Parking
 - ~~Yes.~~ **Required.**

8. External Elements

Intent: Guide the integration of external elements into property development including landscaping, utilities and lighting. Refer to Sec. 4.1.4.E, Signage and Sec. 4.1.4.F, Lighting and Noise.

Storefront Signage

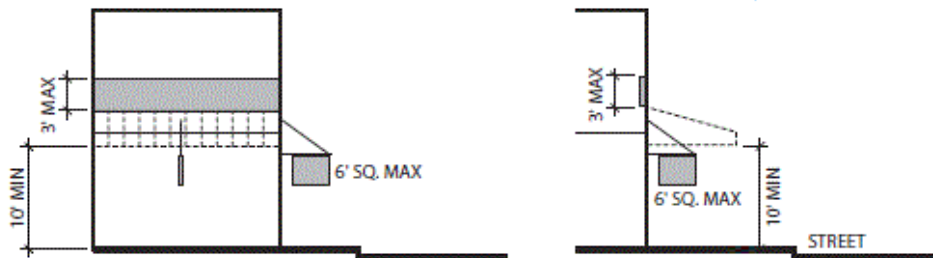

a. Proposed Topography Grades

Provide grading plan with 2 foot contours.

b. Side or Rear Privacy Fence or Wall

Maximum of 8 feet.

c. Front Fence Or Wall

Maximum of 3 feet 6 inches.

d. Landscape Vegetation

- i. Minimum of 8 trees (with a 2 inch minimum caliper) per acre of open space.
- ii. Trees required for surface parking may be counted **toward overall landscape requirement.**
- iii. ~~Maximize shrubs and groundcover per open space.~~

e. Slopes

~~Plant slopes steeper than 3:1 for erosion control.~~

f e. Trash Storage/Recycling, **External Mechanical Units, Electrical Units, and Rain Barrels**

Integrate with building design or screen / conceal from view from public street and riverwalk.

g. ~~External Mechanical Units, Electrical Units and Rain Barrels~~

~~Integrate with building design or screen / conceal from view from public street and riverwalk with no encroachment into setback area.~~

h. ~~Signage~~

~~External band above entry, hanging or blade sign, awning or overhang.~~

i. ~~Lighting Trespass~~

- i. ~~Pre-Curfew Limitations for Environmental Zone E3.~~
- ii. ~~As Defined by Illuminating Engineers Society of Lighting for Exterior Environment RP-33.~~

~~9. Stormwater Systems~~

~~a. Intent~~

~~Improve water quality in streams and river by reducing stormwater runoff volume, temperature and velocity.~~

~~b. Piped Roof Water~~

~~If a closed drainage system, then no treatment necessary.~~

~~c. Ground Surface Runoff In Areas With Subsoil~~

~~Detain first 0.5 inch rain and percolate into ground, or release within 24 hour minimum and 72 hour maximum.~~

~~d. Ground Surface Runoff In Areas Of Rock and/or Contamination~~

~~Detain first 0.5 inch rain and treat in a stormwater quality structure before discharging to a closed drainage system.~~

40 9. Sustainability

a. Intent

Encourage longevity, durability, energy and economic efficiency as well as improved environmental conditions.

b. Green Building and Landscape

- i. Capable of attaining the **current** Leadership in Energy and Environmental Design (LEED) minimal Performance Level of "Certified."
- ii. Submit completed worksheet of appropriate LEED standard to demonstrate pre-certification estimate.

c. Reflectivity, Heat Island Reduction, Roof and Surface Lots

- i. **Surface lots shall** provide shade and/or use light-colored/high albedo materials with a **solar** reflectance of at least 0.3 **(30%)**.
- ii. Roofs shall use an Energy Star Compliant (highly reflective) ~~and high emissivity roofing (emissivity of at least 0.9)~~ for a minimum of 75% of the roof surface.

E. SW4 City View, Campus Cove and Quay Village



1. Vision and Intent

These three new development districts are clustered around privately-owned but publicly-accessed marinas, lending these areas a distinctively urban character that will enliven the new Knoxville South Waterfront. Higher density and larger in scale, these buildings have a mix of uses, including office, residential, commercial and hospitality. All new developments shall integrate publicly accessible landscapes and plazas that unify the buildings with a setback from the river to accommodate a continuous promenade and marinas. View corridors and public open spaces will connect these areas to the neighborhoods, civic spaces and natural drainage ways to the river.

Parking is incorporated into the structures or housed beneath the buildings when possible. Large surface parking lots are discouraged. A possible pedestrian connection to the University of Tennessee will facilitate a continuation of the student population into the Campus Cove. The Sevier Avenue extension from the James White Parkway will be realigned with a traffic circle to improve traffic flow and create a sense of entry into the downtown. A second traffic circle will be introduced along Island Home Avenue.



2. Existing Conditions

a. Intent

Guide site survey to assess existing site conditions for constraints and opportunities. Direct views to river and downtown, when viewed from neighborhoods behind.

b. Topography

Consider existing topography and provide topographic survey with 2 foot contours.

c. Existing Trees

- i. Identify all existing trees with a 6 inch minimum caliper including root zone within dripline.
- ii. Preserve a minimum of 1 healthy large canopy tree per lot, or 6 healthy trees per acre, whichever is greater.

~~d. 100-Year Flood Lines~~

- ~~i. Tennessee River 100-Year flood line is EL 821.5.~~
- ~~ii. Preserve Goose Creek TVA flowage easement at 822.~~
- ~~iii. No fill or study to show "no rise" certification.~~

~~e. 500-Year Flood Lines~~

~~Lowest habitable floor elevation is EL 828.8.~~

~~f.d. Environmental and Archaeological~~

~~Comply with State and Federal Requirements.~~

~~Report on environmental and/or archaeological findings.~~

3. Block Layout

a. Intent

Guide lot layout and outline the maximum block perimeter and building setbacks permitted in this district to ensure walkable neighborhoods.

b. Block Size

Maximum perimeter of 1,400 feet.

c. Building Lines

- ~~i. Minimum of 70 feet from normal pool EL 813.0. Refer to Sec. 4.1.6, Riverscape Standards.~~
- ~~ii. Minimum of 50 feet from stream centerline.~~

d. Proposed Subdivision and Phasing Plan

Clearly designate future phases and describe proposed subdivision plan and phasing when applicable.

4. Building Siting and Configuration

Intent: Provide building configuration and design parameters, as well as suggestions for building function.

Axonometric Diagram

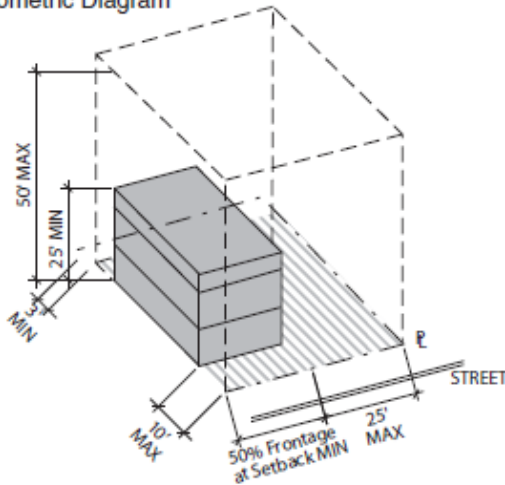

Section Height and Siting

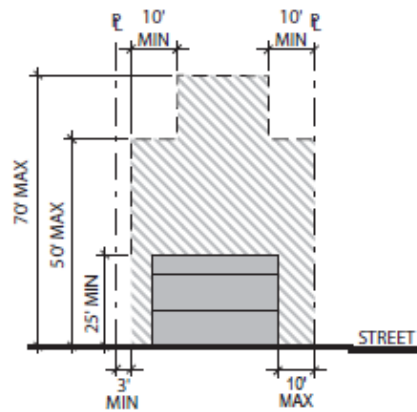

Plan Width and Siting

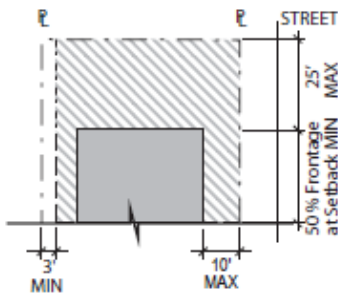

Definitions

- Maximum building outline
- Minimum building outline
- P = Property line

*75% Frontage at Setback is applicable to Sevier Avenue only. All other streets have a 40% Frontage at Setback MIN requirement.

Principal Building Siting	
Orientation	NA
Front Setback (max)	10'
Frontage at Setback (min)	50%
Side Setback (max)	25'
Rear Setback (min)	3'
Lot Size (max)	3 acres
Building Coverage (max)	80%
Open Space Coverage (min)	20%

Principal Building Configuration	
Building Width	NA
Building Height (min)	25' & 2 Story
Building Height (max)	50' & 4 Story plus 20' and 2 Story max at Setback + 10'
Footprint / Floor Plate (max)	30,000 SF; Does not apply to structured parking footprint
Floor Area Ratio (max)	4

5. Ancillary Structures and Outdoor Spaces

a. Intent

Provide outdoor space configuration and design parameters.

b. Ancillary/Accessory Structures

NA

c. Ancillary/Accessory Structure Envelope

i. Footprint/Floor Plate: NA

ii. Front Setback: NA

iii. Frontage at Setback: NA

iv. Side Setback: NA

v. Rear Setback: NA

vi. Building Width: NA

vii. Building Height: NA

d. Outdoor Space Types

Courtyards, plazas, pools

e. Usable Private Open Space

NA

6. Building Frontages

Frontage Typologies: Refer to Sec. 4.1.4.C.

Definitions

 Building outline

Porch

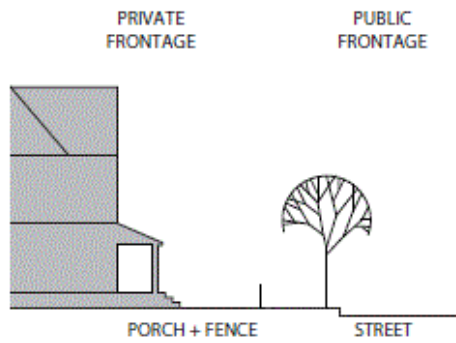

Stoop

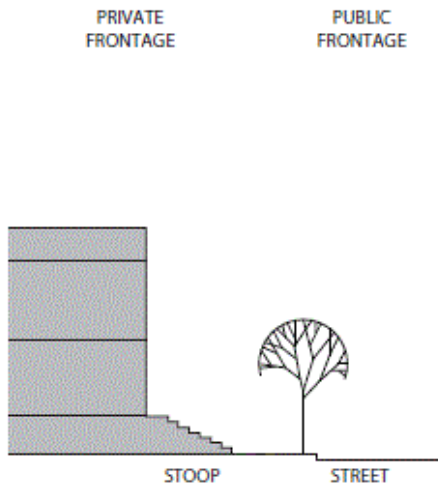

Storefront

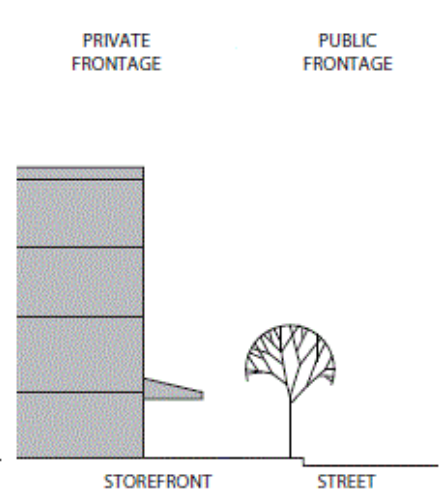

Building Entries

Primary entry on principal frontage

Building Envelope Articulation

Ground Level	Min 70% transparent glass at the ground level on principal frontage
Facade Length	NA
Facade Openings	Openings on the principal frontage shall be min 25% of the building wall area
Roofs	Buildings may have flat or sloped roofs
Other	Balconies, porches, bay windows and other projections are encouraged and may be incorporated into the building setback

7. Off Street Parking and Loading

Intent: Provide with adequate parking to accommodate the district's various building types and functions. Refer to Sec. 4.1.4.D.

Structured Parking with Vegetation Buffer

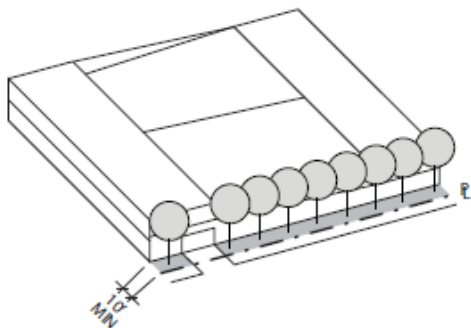

Structured Parking with Building Buffer

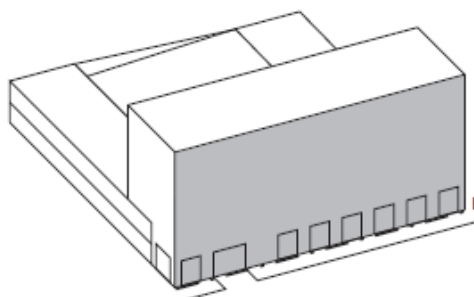

Structured Parking with Screening

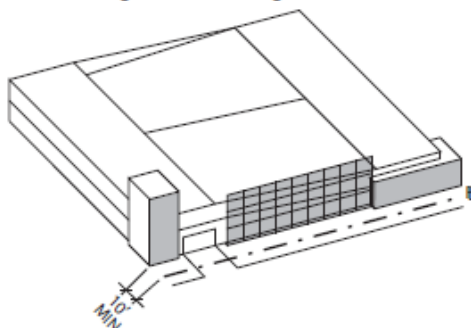

Surface Parking with Vegetation Buffer and Low Wall

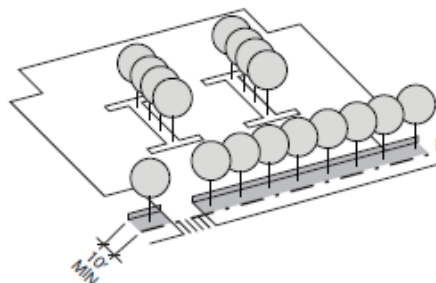

a. Parking Types

Surface lot, above ground structure, basement garage.

b. Parking Spaces, Reserved and Shared

Maximum of 3 parking spaces per 1,000 square feet and maximum of 2 parking spaces per residential unit.

c. Pavements

65% minimum of uncovered **surface parking vehicular pavements** shall be **permeable porous** (a minimum of 8% openings) while meeting overall stormwater requirements.

d. Garage Location

To rear or side of property or underneath building.

e. Screening and Shading

One tree (with a 2 inch minimum caliper) is required for every 5 surface parking spaces, to

be planted in a minimum 5 foot wide vegetated islands and/or medians.

f. Accessible Spaces and Routes

Meet or exceed city accessibility standards.

g. Driveways and Curb Cuts

- i. Driveway shall be ~~40~~ **15** foot maximum for one way traffic and ~~24~~ **26** foot maximum for two way traffic.
- ii. Sidewalk materials and patterning is continuous through driveway.

h. Garage Entry

Permitted on all frontages.

i. Service Loading

~~Yes. Permitted.~~

j. Bicycle Parking

~~Yes. Required.~~

8. External Elements

Intent: Guide the integration of external elements into property development including landscaping, utilities and lighting. Refer to Sec. 4.1.4.E, Signage and Sec. 4.1.4.F, Lighting and Noise.

Storefront Signage

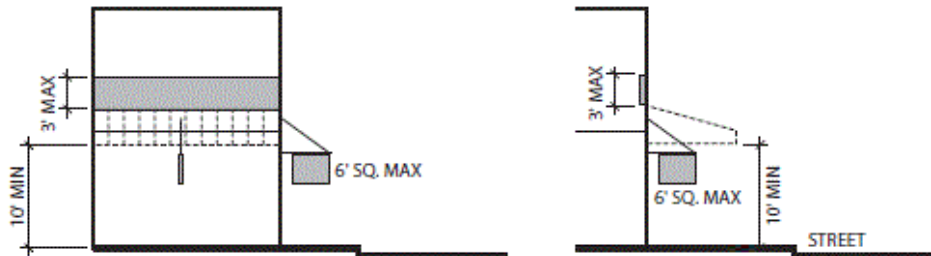

a. Proposed Topography Grades

Provide grading plan with 2 foot contours.

b. Side or Rear Privacy Fence or Wall

Maximum of 8 feet.

c. Front Fence Or Wall

Maximum of 3 feet 6 inches.

d. Landscape Vegetation

- i. Minimum of 8 trees (with a 2 inch minimum caliper) per acre of open space.
- ii. Trees required for surface parking may be counted **toward overall landscape requirement.**
- iii. ~~Maximize shrubs and groundcover per open space.~~

e. Slopes

~~Plant slopes steeper than 3:1 for erosion control.~~

f e. Trash Storage/Recycling, **External Mechanical Units, Electrical Units, and Rain Barrels**

Integrate with building design or screen / conceal from view from public street and riverwalk.

g. ~~External Mechanical Units, Electrical Units and Rain Barrels~~

~~Integrate with building design or screen / conceal from view from public street and riverwalk with no encroachment into setback area.~~

h. ~~Signage~~

~~External band above entry, hanging or blade sign, awning or overhang.~~

i. ~~Lighting Trespass~~

- i. ~~Pre-Curfew Limitations for Environmental Zone E3.~~
- ii. ~~As Defined by Illuminating Engineers Society of Lighting for Exterior Environment RP-33.~~

~~9. Stormwater Systems~~

~~a. Intent~~

~~Improve water quality in streams and river by reducing stormwater runoff volume, temperature and velocity.~~

~~b. Piped Roof Water~~

~~If a closed drainage system, then no treatment necessary.~~

~~c. Ground Surface Runoff In Areas With Subsoil~~

~~Detain first 0.5 inch rain and percolate into ground, or release within 24 hour minimum and 72 hour maximum.~~

~~d. Ground Surface Runoff In Areas Of Rock and/or Contamination~~

~~Detain first 0.5 inch rain and treat in a stormwater quality structure before discharging to a closed drainage system.~~

9. Sustainability

a. Intent

Encourage longevity, durability, energy and economic efficiency as well as improved environmental conditions.

b. Green Building and Landscape

- i. Capable of attaining the **current** Leadership in Energy and Environmental Design (LEED) minimal Performance Level of "Certified."
- ii. Submit completed worksheet of appropriate LEED standard to demonstrate pre-certification estimate.

c. Reflectivity, Heat Island Reduction, Roof and Surface Lots

- i. **Surface lots shall** provide shade and/or use light-colored/high albedo materials with a **solar** reflectance of at least 0.3 **(30%)**.
- ii. Roofs shall use an Energy Star Compliant (highly reflective) ~~and high emissivity roofing (emissivity of at least 0.9)~~ for a minimum of 75% of the roof surface.

F. SW5 Bell Tower Walk



1. Vision and Intent

This bustling area caters to multiple functions, including retail, entertainment, civic, cultural, and residential uses. New buildings are organized along the civic plaza called “Bell Tower Walk” and are oriented perpendicular to the river so as not to inhibit views to the river from the bluff. The Bell Tower Walk is the center of a lively area on the Knoxville South Waterfront where outdoor restaurants, fairs and musical events attract local Knoxvilleians and regional visitors both day and night and year round. Bell Tower Walk creates a “window-to-the-water” from the Baptist Church on Sevier Avenue leading down to the riverfront. It will serve as the central celebratory space for the community and could be used in conjunction with marketplace piers for small-scale festivals and urban markets throughout the year. Low to mid-rise, mixed-use or multiple unit housing developments face this linear open space and are encouraged to have commercial development on the first floor. To the west of this civic plaza, a cultural center and museum overlooks an outdoor amphitheater and marina that connect to the river walk. Parking structures are housed beneath the buildings or behind them to accommodate the area’s many visitors and employees.



2. Existing Conditions and Block Layout

a. Intent

Guide site survey to assess existing site conditions for constraints and opportunities. Allow some views to river and downtown from taller buildings, when viewed from neighborhoods behind.

b. Topography

Consider existing topography and provide topographic survey with 2 foot contours.

c. Existing Trees

- i. Identify all existing trees with a 6 inch minimum caliper including root zone within dripline.
- ii. Preserve a minimum of 1 healthy large canopy tree per lot, or 6 healthy trees per acre, whichever is greater.

~~d. 100-Year Flood Lines~~

- ~~i. Tennessee River 100-Year flood line is EL 821.5.~~
- ~~ii. No fill or study to show "no rise" certification.~~

~~e. 500-Year Flood Lines~~

~~Lowest habitable floor elevation is EL 828.8.~~

~~f d. Environmental and Archaeological~~

- ~~i. Comply with State and Federal Requirements.~~
- ~~ii. Report on environmental and/or archaeological findings.~~

3. Block Layout

a. Intent

Guide lot layout and outline the maximum block perimeter and building setbacks permitted in this district to ensure walkable neighborhoods.

b. Block Size

Maximum perimeter of 1,400 feet.

c. Building Lines

- ~~i. Minimum of 70 feet from normal pool EL 813.0. Refer to Sec. 4.1.6, Riverscape Standards.~~
- ~~ii. Minimum of 50 feet from stream centerline.~~

d. Proposed Subdivision and Phasing Plan

Clearly designate future phases and describe proposed subdivision plan and phasing when applicable.

4. Building Siting and Configuration

Intent: Provide building configuration and design parameters, as well as suggestions for building function.

Axonometric Diagram

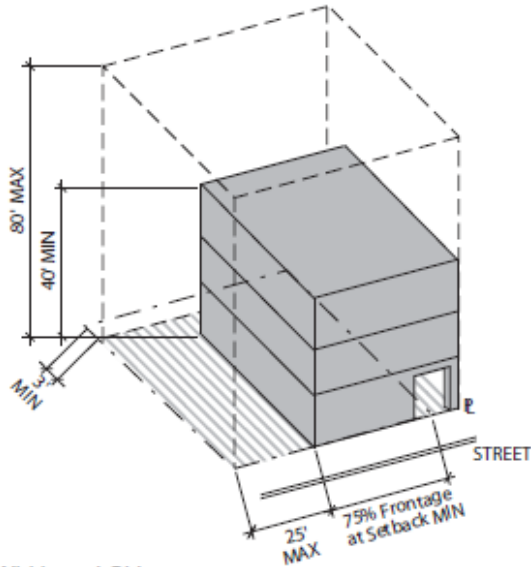

Section Height and Siting

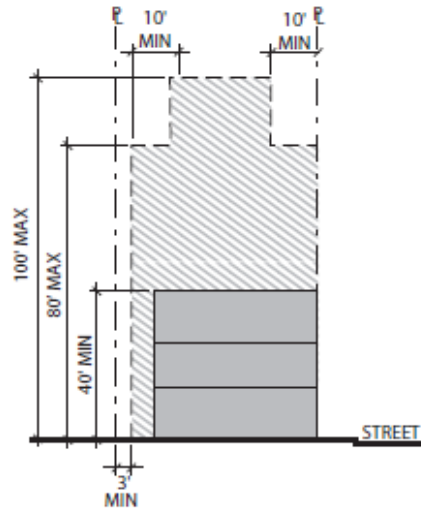

Plan Width and Siting

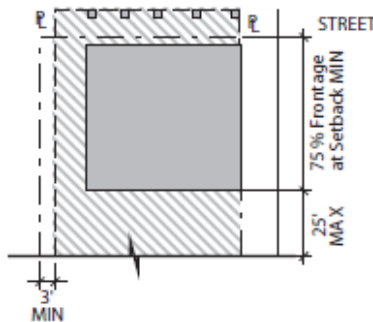

Definitions

- Maximum building outline
- Minimum building outline
- = Property line

Principal Building Siting	
Orientation	NA
Front Setback	0'
Frontage at Setback (min)	75% to River Rd. and Sevier Ave.
Side Setback (max)	25'
Rear Setback (min)	3'
Lot Size (max)	3 acres
Building Coverage (max)	90%
Open Space Coverage (min)	10%

Principal Building Configuration	
Building Width	NA
Building Height (min)	40' & 3 Story
Building Height (max)	80' & 7 Stories plus 20' and 2 Story max at Setback + 10'
Footprint / Floor Plate (max)	30,000 SF; Does not apply to structured parking footprint
Floor Area Ratio (max)	7

5. Ancillary Structures and Outdoor Spaces

a. Intent

Provide outdoor space configuration and design parameters.

b. Ancillary/Accessory Structures

NA

c. Ancillary/Accessory Structure Envelope

i. Footprint/Floor Plate: NA

ii. Front Setback: NA

iii. Frontage at Setback: NA

iv. Side Setback: NA.

v. Rear Setback: NA

vi. Building Width: NA

vii. Building Height: NA

d. Outdoor Space Types

Courtyards, plazas, mall

e. Usable Private Open Space

NA

6. Building Frontages

Frontage Typologies: Refer to Sec. 4.1.4.C.

Definitions

 Building outline

Storefront

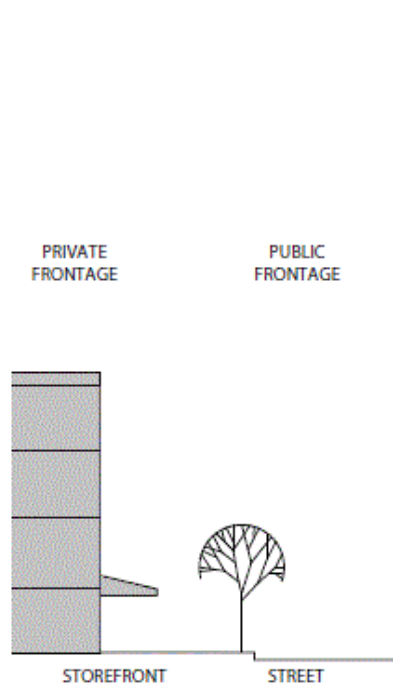

Gallery

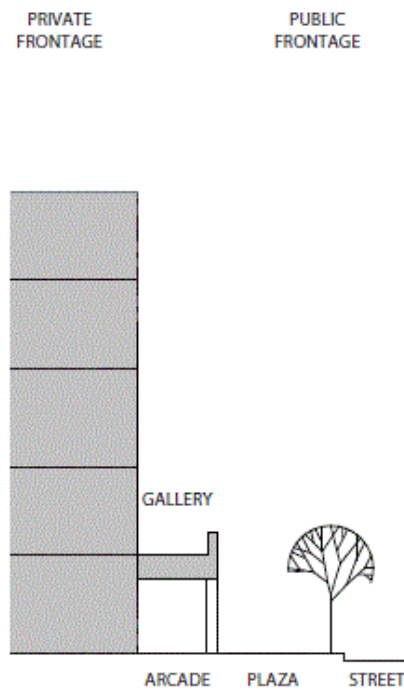

Arcade

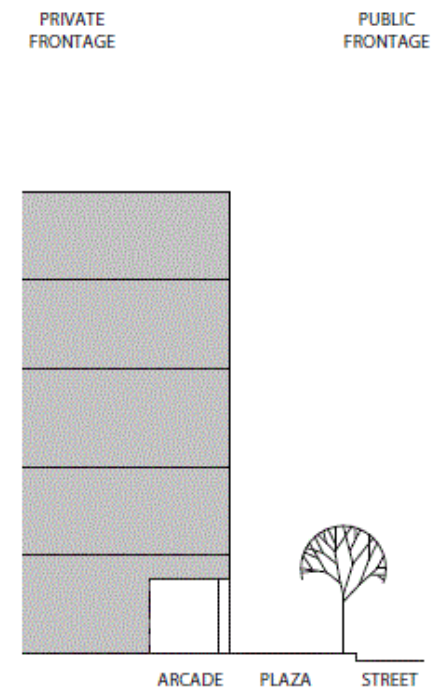

Building Entries

Primary entry on principal frontage

Building Envelope Articulation

Ground Level	Min 70% transparent glass at the ground level on the principal frontage
Facade Length	NA
Facade Openings	Openings above the first story on the principal frontage shall be min 25% of the building wall area
Roofs	Buildings may have flat or sloped roofs
Other	Balconies, porches, bay windows and other projections are encouraged and may be incorporated into the building setback

7. Off Street Parking and Loading

Intent: Provide with adequate parking to accommodate the district's various building types and functions. Refer to Sec. 4.1.4.D.

Structured Parking with Vegetation Buffer

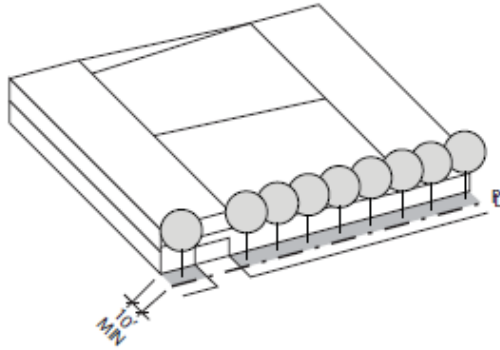

Structured Parking with Building Buffer

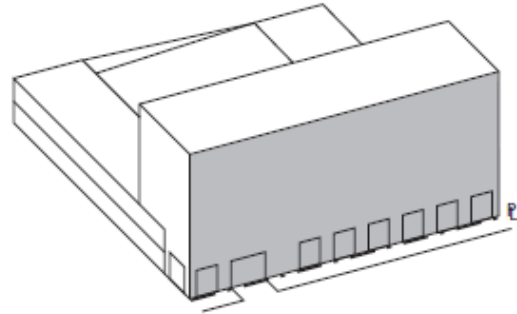

Structured Parking with Screening

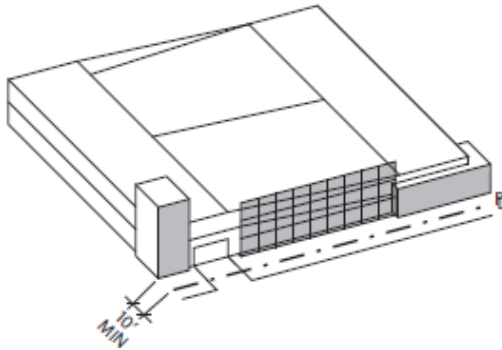

Surface Parking with Vegetation Buffer and Low Wall

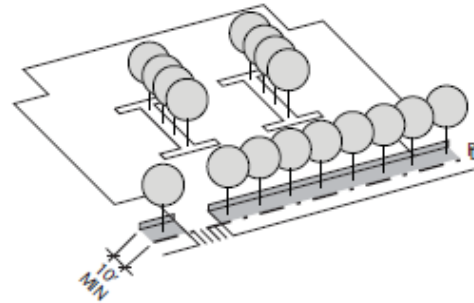

a. Parking Types

Surface lot, above ground structure, basement garage.

b. Parking Spaces, Reserved and Shared

Maximum of 3 parking spaces per 1,000 square feet and maximum of 2 parking spaces per residential unit.

c. Pavements

65% minimum of uncovered **surface parking vehicular pavements** shall be **permeable porous** (a minimum of 8% openings) while meeting overall stormwater requirements.

d. Garage Location

To rear or center of property or underneath building.

e. Screening and Shading

One tree (with a 2 inch minimum caliper) is required for every 5 surface parking spaces, ~~to be planted in a minimum 5 foot wide vegetated~~

~~islands and/or medians.~~

f. Accessible Spaces and Routes

Meet or exceed city accessibility standards.

g. Driveways and Curb Cuts

i. Driveway shall be ~~40~~ **15** foot maximum for one way traffic and ~~24~~ **26** foot maximum for two way traffic.

ii. Sidewalk materials and patterning is continuous through driveway.

h. Garage Entry

Permitted on all frontages.

i. Service Loading

~~Yes.~~ **Permitted.**

j. Bicycle Parking

~~Yes.~~ **Required.**

8. External Elements

Intent: Guide the integration of external elements into property development including landscaping, utilities and lighting. Refer to Sec. 4.1.4.E, Signage and Sec. 4.1.4.F, Lighting and Noise.

Storefront Signage

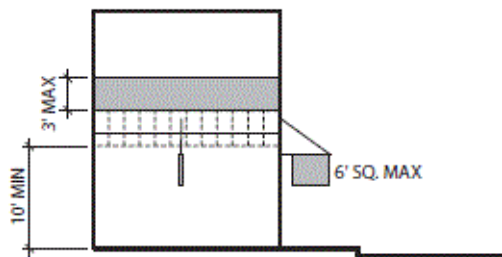

Wall Signage

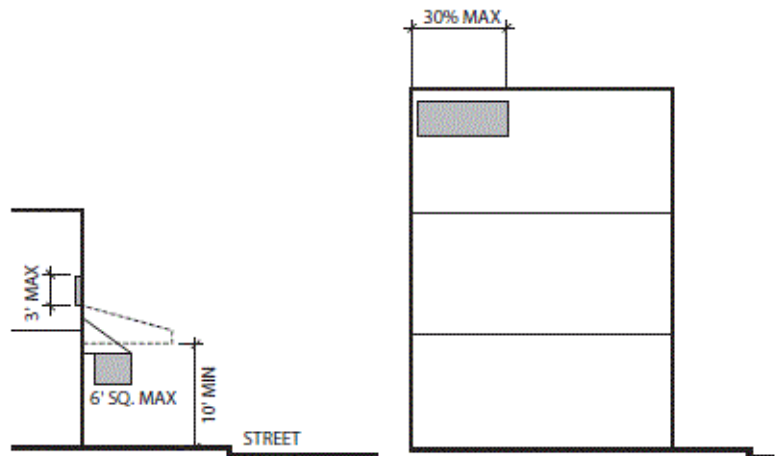

a. Proposed Topography Grades

Provide grading plan with 2 foot contours.

b. Side or Rear Privacy Fence or Wall

Maximum of 8 feet.

c. Front Fence Or Wall

Maximum of 3 feet and 6 inches.

d. Landscape Vegetation

- i. Minimum of 8 trees (with a 2 inch minimum caliper) per acre of open space.
- ii. Trees required for surface parking may be counted **toward overall landscape requirement.**
- iii. ~~Maximize shrubs and groundcover per open space.~~

e. ~~Slopes~~

~~Plant slopes steeper than 3:1 for erosion control.~~

f e. Trash Storage/Recycling, **External Mechanical Units, Electrical Units, and Rain Barrels**

Integrate with building design or screen / conceal from view from public street and riverwalk.

g. ~~External Mechanical Units, Electrical Units and Rain Barrels~~

~~Integrate with building design or screen / conceal from view from public street and riverwalk with no encroachment into setback area.~~

h. ~~Signage~~

~~External band above entry, hanging or blade sign, awning or overhang.~~

i. ~~Lighting Trespass~~

- i. ~~Pre-Curfew Limitations for Environmental Zone E4.~~
- ii. ~~As Defined by Illuminating Engineers Society of Lighting for Exterior Environment RP-33.~~

~~9. Stormwater Systems~~

~~a. Intent~~

~~Improve water quality in streams and river by reducing stormwater runoff volume, temperature and velocity.~~

~~b. Piped Roof Water~~

~~If a closed drainage system, then no treatment necessary.~~

~~c. Ground Surface Runoff In Areas With Subsoil~~

~~Detain first 0.5 inch rain and percolate into ground, or release within 24 hour minimum and 72 hour maximum.~~

~~d. Ground Surface Runoff In Areas Of Rock and/or Contamination~~

~~Detain first 0.5 inch rain and treat in a stormwater quality structure before discharging to a closed drainage system.~~

9. Sustainability

a. Intent

Encourage longevity, durability, energy and economic efficiency as well as improved environmental conditions.

b. Green Building and Landscape

- i. Capable of attaining the **current** Leadership in Energy and Environmental Design (LEED) minimal Performance Level of "Certified."
- ii. Submit completed worksheet of appropriate LEED standard to demonstrate pre-certification estimate.

c. Reflectivity, Heat Island Reduction, Roof and Surface Lots

- i. **Surface lots shall** provide shade and/or use light-colored/high albedo materials with a **solar** reflectance of at least 0.3 (**30%**).
- ii. Roofs shall use an Energy Star Compliant (highly reflective) and high emissivity roofing (emissivity of at least 0.9) for a minimum of 75% of the roof surface.

G. SW6 Henley Gateway



1. Vision and Intent

The Henley Gateway establishes a new entrance into downtown Knoxville, as well as a Chapman Highway gateway leading south to the Smoky Mountains. Capitalizing on the presence and economic opportunities of the Baptist Hospital, this area shall host multi-story office buildings, attracting new businesses to South Knoxville. A high-rise hotel with sweeping river views could accommodate business professionals as well as a multitude of city visitors.

The dominant open green space in the shape of a triangular wedge is organized according to the proposed development as well as towards Chapman Highway. The park space provides views to the river and downtown and contains a parking garage underneath. New mid-rise towers facing the park are envisioned as a compliment to the surrounding institutional uses and to the scale of the Baptist Hospital. Landscaped plazas not only provide professionals with pleasant lunchtime spaces, but also establish a pedestrian-friendly connection from City View to Bell Tower Walk and Waterfront Marketplace. A setback from the river allows for existing and new development to access a continuous Shoals Promenade Riverwalk. A potential conversion of the freight rail line to future light rail may provide public transportation to this district.



2. Existing Conditions

a. Intent

Guide site survey to assess existing site conditions for constraints and opportunities. Allow Some views to river and downtown from taller buildings.

b. Topography

Consider existing topography and provide topographic survey with 2 foot contours.

c. Existing Trees

- i. Identify all existing trees with a a 6 inch minimum caliper including root zone within dripline.
- ii. Preserve a minimum of 1 healthy large canopy tree per lot, or 6 healthy trees per acre, whichever is greater.

~~d. 100-Year Flood Lines~~

- ~~i. Tennessee River 100-Year flood line is EL 821.5.~~
- ~~ii. No fill or study to show "no rise" certification.~~

~~e. 500-Year Flood Lines~~

~~Lowest habitable floor elevation is EL 828.8.~~

~~f.c. Environmental and Archaeological~~

- ~~i. Comply with State and Federal Requirements.~~
- ~~ii. Report on environmental and/or archaeological findings.~~

3. Block Layout

a. Intent

Guide lot layout and outline the maximum block perimeter and building setbacks permitted in this district to ensure walkable neighborhoods.

b. Block Size

Maximum perimeter of 1,400 feet.

c. Building Lines

- ~~i. Minimum of 70 feet from normal pool EL 813.0. Refer to Sec. 4.1.6, Riverscape Standards.~~
- ~~ii. Minimum of 50 feet from stream centerline.~~

d. Proposed Subdivision and Phasing Plan

Clearly designate future phases and describe proposed subdivision plan and phasing when applicable.

4. Building Siting and Configuration

Intent: Provide building configuration and design parameters, as well as suggestions for building function.

Axonometric Diagram

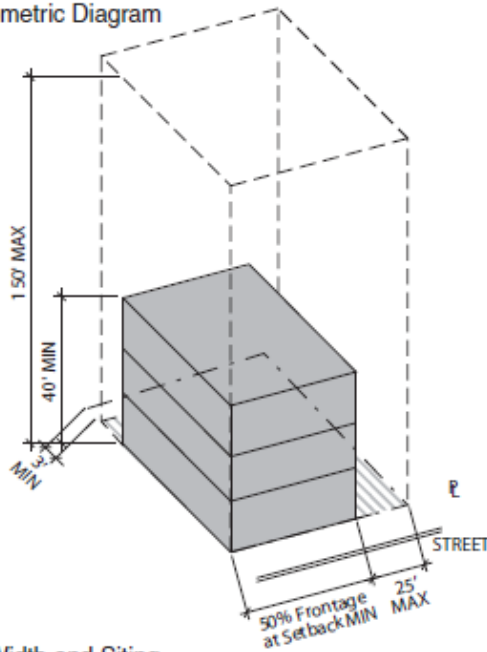

Section Height and Siting

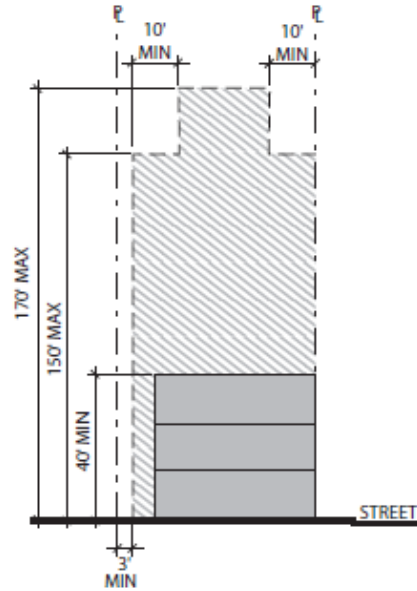

Plan Width and Siting

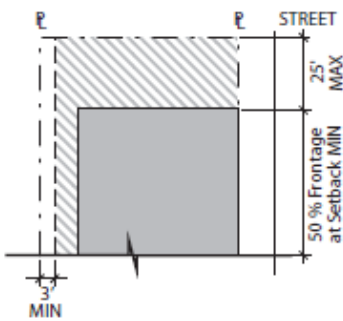

Definitions

- Maximum building outline
- Minimum building outline
- = Property line

Principal Building Siting	
Orientation	NA
Front Setback	0'
Frontage at Setback (min)	50%
Side Setback (max)	25'
Rear Setback (min)	3'
Lot Size (max)	3 acres
Building Coverage (max)	90%
Open Space Coverage (min)	10%

Principal Building Configuration	
Building Width	NA
Building Height (min)	40' & 3 Story
Building Height (max)	150' & 12 Stories plus 20' and 2 Story max at Setback + 10'
Footprint / Floor Plate (max)	50,000 SF; Does not apply to structured parking footprint
Floor Area Ratio (max)	11

5. Ancillary Structures and Outdoor Spaces

a. Intent

Provide outdoor space configuration and design parameters.

b. Ancillary/Accessory Structures

NA

c. Ancillary/Accessory Structure Envelope

i. Footprint/Floor Plate: NA

ii. Front Setback: NA

iii. Frontage at Setback: NA

iv. Side Setback: NA

v. Rear Setback: NA

vi. Building Width: NA

vii. Building Height: NA

d. Outdoor Space Types

Rooftop landscape

e. Usable Private Open Space

NA

6. Building Frontages

Frontage Typologies: Refer to Sec. 4.1.4.C.

Definitions



Storefront

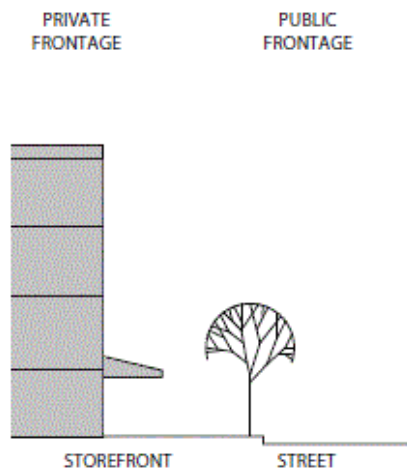

Gallery

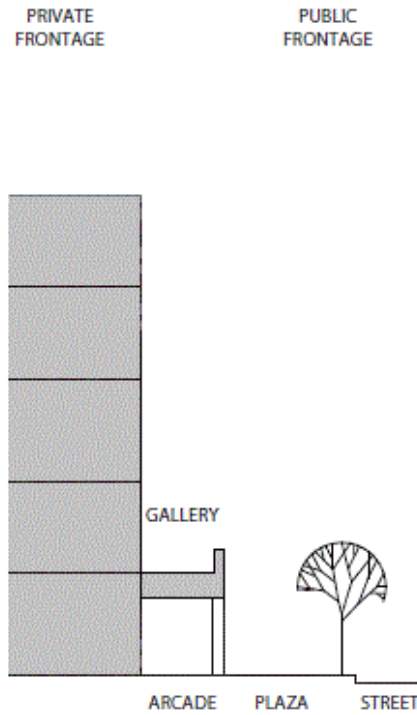

Arcade

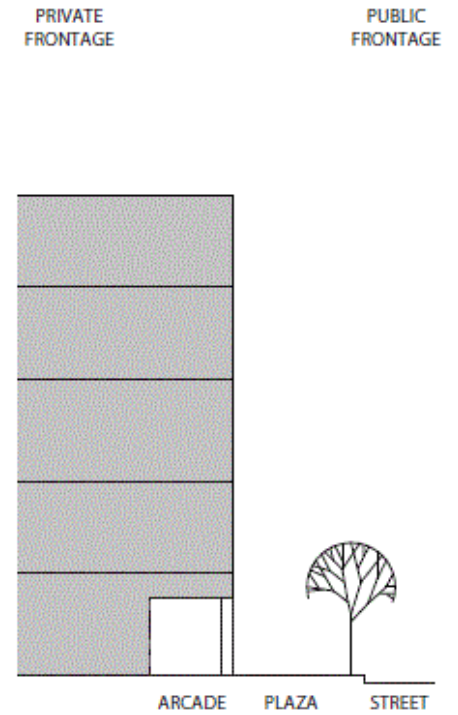

Building Entries

Primary entry on principal frontage

Building Envelope Articulation

Ground Level	Min 70% transparent glass at the ground level on the principal frontage
Facade Length	NA
Facade Openings	Openings above the first story on the principal frontage shall be min 25% of the building wall area
Roofs	Buildings may have flat or sloped roofs
Other	Balconies, porches, bay windows and other projections are encouraged and may be incorporated into the building setback

7. Off Street Parking and Loading

Intent: Provide with adequate parking to accommodate the district's various building types and functions. Refer to Sec. 4.1.4.D.

Structured Parking with Vegetation Buffer

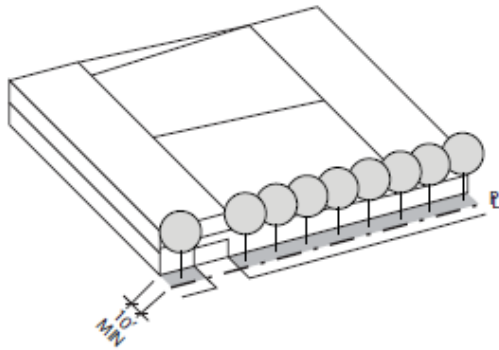

Structured Parking with Building Buffer

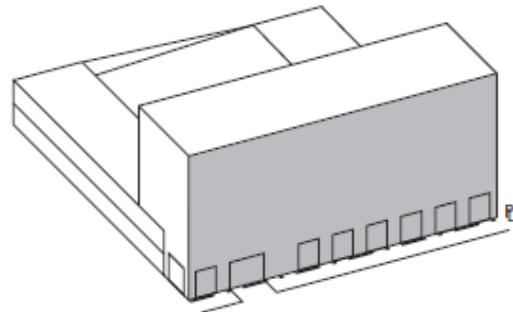

Structured Parking with Screening

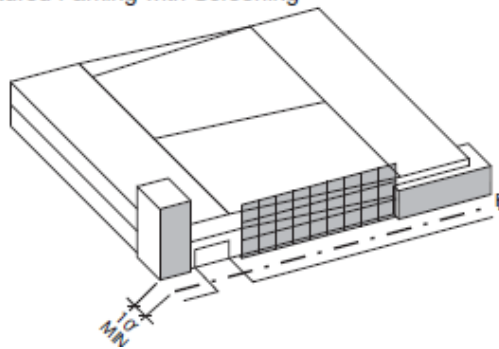

Surface Parking with Vegetation Buffer and Low Wall

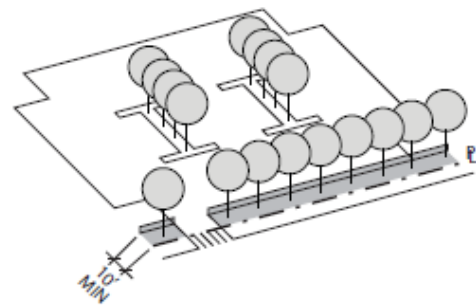

a. Parking Types

Surface lot, above ground structure, basement garage.

b. Parking Spaces, Reserved and Shared

Maximum of 3 parking spaces per 1,000 square feet and maximum of 2 parking spaces per residential unit.

c. Pavements

65% minimum of uncovered **surface parking vehicular pavements** shall be **permeable porous** (a minimum of 8% openings) while meeting overall stormwater requirements.

d. Garage Location

To rear or center of property or underneath building.

e. Screening and Shading

One tree (with a 2 inch minimum caliper) is required for every 5 surface parking spaces, to be planted in a minimum 5 foot wide vegetated islands and/or medians.

f. Accessible Spaces and Routes

Meet or exceed city accessibility standards.

g. Driveways and Curb Cuts

i. Driveway shall be ~~40~~ **15** foot maximum for one way traffic and ~~24~~ **26** foot maximum for two way traffic.

ii. Sidewalk materials and patterning is continuous through driveway.

h. Garage Entry

Permitted on all frontages.

i. Service Loading

~~Yes.~~ **Permitted.**

j. Bicycle Parking

~~Yes.~~ **Required.**

8. External Elements

Intent: Guide the integration of external elements into property development including landscaping, utilities and lighting. Refer to Sec. 4.1.4.E, Signage and Sec. 4.1.4.F, Lighting and Noise.

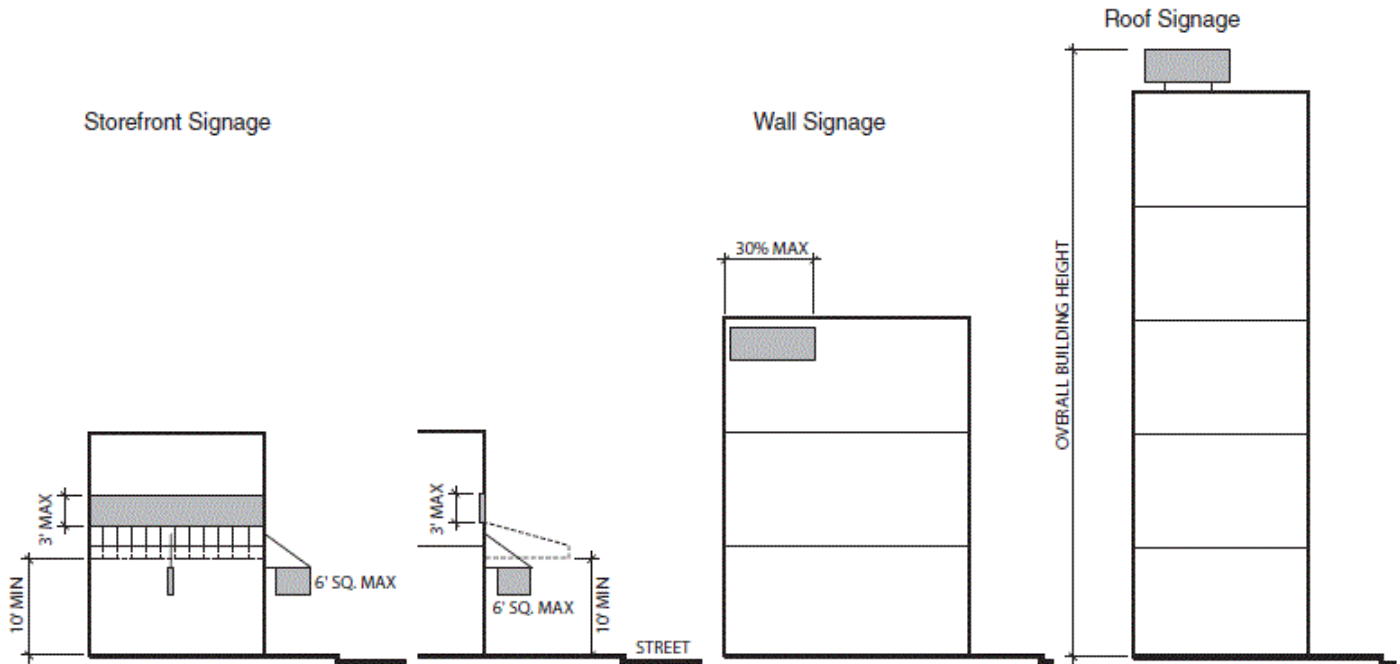

a. Proposed Topography Grades

Provide grading plan with 2 foot contours.

b. Side or Rear Privacy Fence or Wall

Maximum of 8 feet.

c. Front Fence Or Wall

Maximum of 3 feet 6 inches.

d. Landscape Vegetation

i. Minimum of 8 trees (with a 2 inch minimum caliper) per acre of open space

ii. Trees required for surface parking may be counted **toward overall landscape requirement.**

iii. ~~Maximize shrubs and groundcover per open space.~~

e. Slopes

~~Plant slopes steeper than 3:1 for erosion control.~~

f e. Trash Storage/Recycling, **External Mechanical Units, Electrical Units, and Rain Barrels**

Integrate with building design or screen / conceal from view from public street and riverwalk.

g. ~~External Mechanical Units, Electrical Units and Rain Barrels~~

~~Integrate with building design or screen / conceal from view from public street and riverwalk with no encroachment into setback area.~~

h. ~~Signage~~

~~External band above entry, hanging or blade sign, awning or overhang.~~

i. ~~Lighting Trespass~~

~~i. Pre-Curfew Limitations for Environmental Zone E4.~~

~~ii. As Defined by Illuminating Engineers Society of Lighting for Exterior Environment RP-33.~~

~~9. Stormwater Systems~~

~~a. Intent~~

~~Improve water quality in streams and river by reducing stormwater runoff volume, temperature and velocity.~~

~~b. Piped Roof Water~~

~~If a closed drainage system, then no treatment necessary.~~

~~c. Ground Surface Runoff In Areas With Subsoil~~

~~Detain first 0.5 inch rain and percolate into ground, or release within 24 hour minimum and 72 hour maximum.~~

~~d. Ground Surface Runoff In Areas Of Rock and/or Contamination~~

~~Detain first 0.5 inch rain and treat in a stormwater quality structure before discharging to a closed drainage system.~~

40 9. Sustainability

a. Intent

Encourage longevity, durability, energy and economic efficiency as well as improved environmental conditions.

b. Green Building and Landscape

- i. Capable of attaining the **current** Leadership in Energy and Environmental Design (LEED) minimal Performance Level of "Certified."
- ii. Submit completed worksheet of appropriate LEED standard to demonstrate pre-certification estimate.

c. Reflectivity, Heat Island Reduction, Roof and Surface Lots

- i. **Surface lots shall** provide shade and/or use light-colored/high albedo materials with a **solar** reflectance of at least 0.3 (**30%**).
- ii. Roofs shall use an Energy Star Compliant (highly reflective) and high emissivity roofing (emissivity of at least 0.9) for a minimum of 75% of the roof surface.

H. SW7 Waterfront Marketplace



1. Vision and Intent

This area is an extension of the Bell Tower Walk. It is envisioned as a highly active commercial, entertainment, and residential environment. Bound between a newly established Waterfront Drive and the riverfront setback, the new Waterfront Piers provide an elegant setting for restaurants and various retail and entertainment enterprises. These uses define associated civic plazas that unite the buildings with the Riverwalk and the Gay Street Amphitheater.

Developments on this site shall maximize view corridors to the river by orienting long, horizontal buildings perpendicular to the riverfront. Developments that create a continuous visual barrier to the Tennessee River are not permitted. Surface parking in this district shall be kept to a minimum. A new marina and boat ramp at the base of the Gay Street Bridge invite users to spend time on the water adjacent to the park space.



2. Existing Conditions

a. Intent

Guide site survey to assess existing site conditions for constraints and opportunities. Direct views to river and downtown, viewed from neighborhoods behind.

b. Topography

Consider existing topography and provide topographic survey with 2 foot contours.

c. Existing Trees

- i. Identify all existing trees with a 6 inch minimum caliper including root zone within dripline.
- ii. Preserve a minimum of 1 healthy large canopy tree per lot, or 6 healthy trees per acre, whichever is greater.

~~d. 100-Year Flood Lines~~

- ~~i. Tennessee River 100-Year flood line is EL 821.5.~~
- ~~ii. No fill or study to show "no rise" certification.~~

~~e. 500-Year Flood Lines~~

~~Lowest habitable floor elevation EL 828.8.~~

~~f d. Environmental and Archaeological~~

- ~~i. Comply with State and Federal Requirements.~~
- ~~ii. Report on environmental and/or archaeological findings.~~

3. Block Layout

a. Intent

Guide lot layout and outline the maximum block perimeter and building setbacks permitted in this district to ensure walkable neighborhoods.

b. Block Size

Maximum perimeter of 1,400 feet.

c. Building Lines

- ~~i. Minimum of 70 feet from normal pool EL 813.0. Refer to Sec. 4.1.6, Riverscape Standards.~~
- ~~ii. Minimum of 50 feet from stream centerline.~~

d. Proposed Subdivision and Phasing Plan

Clearly designate future phases and describe proposed subdivision plan and phasing when applicable.

4. Building Siting and Configuration

Intent: Provide building configuration and design parameters, as well as suggestions for building function.

Axonometric Diagram

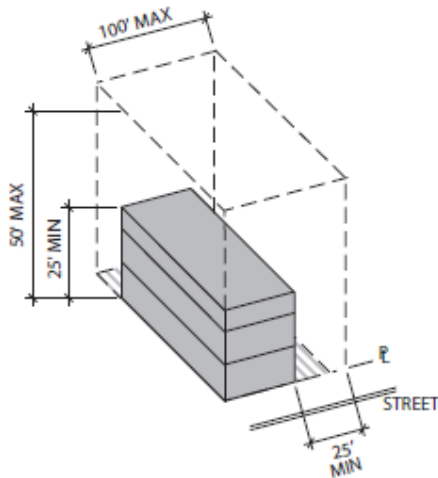

Section Height and Siting

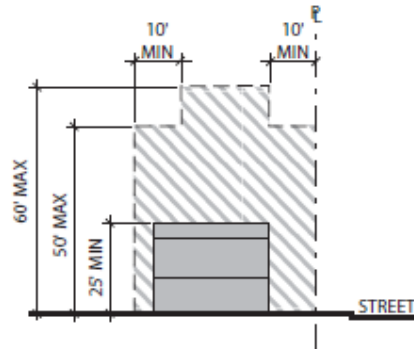

Plan Width and Siting

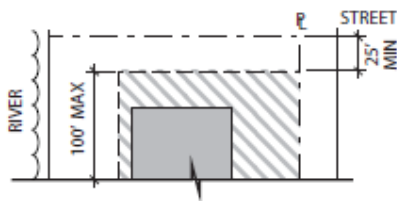

Definitions

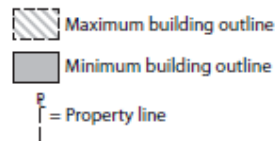

Principal Building Siting	
Orientation	Perpendicular to River
Front Setback	NA
Frontage at Setback	NA
Side Setback (min)	25'
Rear Setback	NA
Lot Size (max)	1 acre
Building Coverage	NA
Open Space Coverage (min)	20%

Principal Building Configuration	
Building Width (max)	70'
Building Height (min)	25' & 2 Story
Building Height (max)	50' & 4 Stories plus 10' and 1 Story max at Setback + 10'
Footprint / Floor Plate (max)	30,000 SF; Does not apply to structured parking footprint
Floor Area Ratio (max)	3

5. Ancillary Structures and Outdoor Spaces

a. Intent

Provide outdoor space configuration and design parameters.

b. Ancillary/Accessory Structures

NA

c. Ancillary/Accessory Structure Envelope

i. Footprint/Floor Plate: NA

ii. Front Setback: NA

iii. Frontage at Setback: NA

iv. Side Setback: NA

v. Rear Setback: NA

vi. Building Width: NA

vii. Building Height: NA

d. Outdoor Space Types

Mall, Plaza

e. Usable Private Open Space

NA

6. Building Frontages

Frontage Typologies: Refer to Sec. 4.1.4.C.

Definitions

 Building outline

Storefront

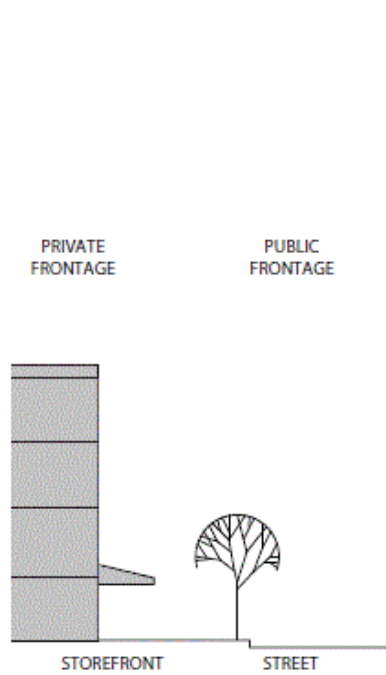

Gallery

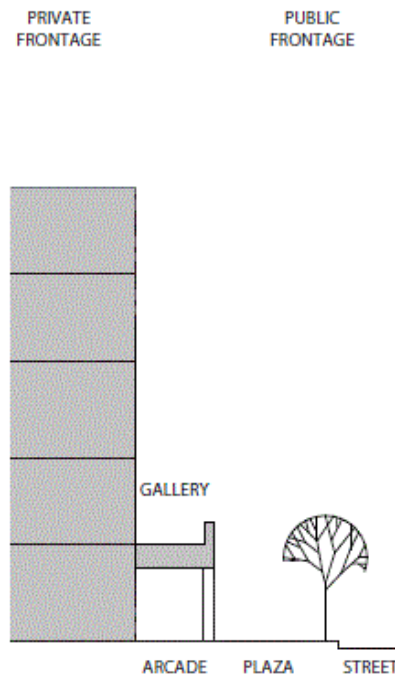

Arcade

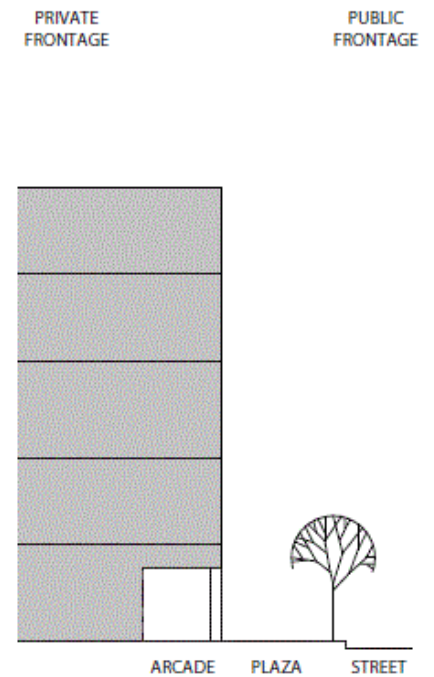

Building Entries

Primary entry on principal frontage

Building Envelope Articulation

Ground Level	Min 70% transparent glass at the ground level on the principal frontage
Facade Length	NA
Facade Openings	Openings above the first story on the principal frontage shall be min 25% of the building wall area
Roofs	Buildings may have flat or sloped roofs
Other	Balconies, porches, bay windows and other projections are encouraged and may be incorporated into the building setback

7. Off Street Parking and Loading

Intent: Provide with adequate parking to accommodate the district’s various building types and functions and maintain the overall neighborhood character. Refer to Sec. 4.1.4.D.

Structured Parking with Vegetation Buffer

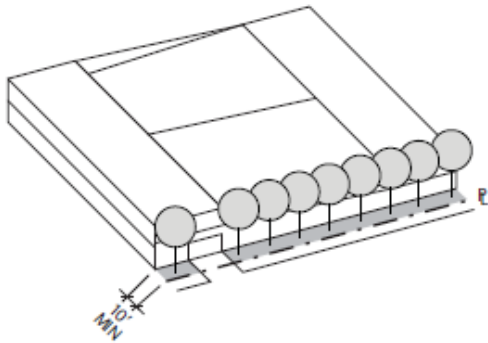

Structured Parking with Building Buffer

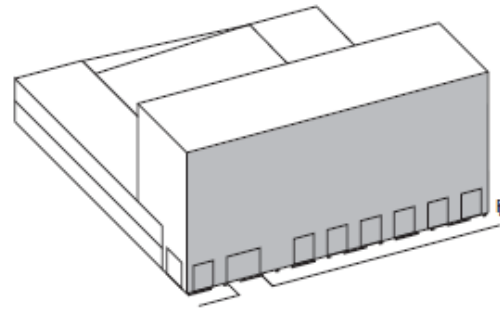

Structured Parking with Screening

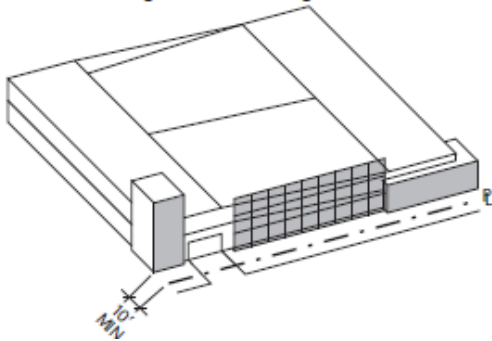

Surface Parking with Vegetation Buffer and Low Wall

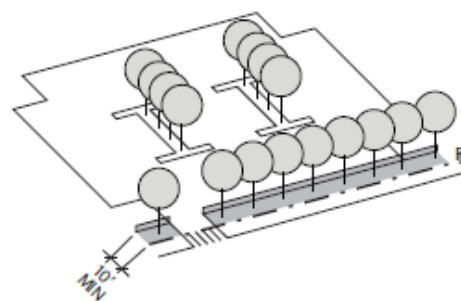

to be planted in a minimum 6-foot wide vegetated islands and/or medians.

- a. Parking Types
 - Surface lot, above ground structure, basement garage.
- b. Parking Spaces, Reserved and Shared
 - Maximum of 3 parking spaces per 1,000 square feet and maximum of 2 parking spaces per residential unit.
- c. Pavements
 - 65% minimum of uncovered **surface parking vehicular pavements** shall be **permeable porous** (a minimum of 8% openings) while meeting overall stormwater requirements.
- d. Garage Location
 - To side of property or underneath building.
- e. Screening and Shading
 - One tree (with a 2 inch minimum caliper) is required for every 5 surface parking spaces, to
- f. Accessible Spaces and Routes
 - Meet or exceed city accessibility standards.
- g. Driveways and Curb Cuts
 - i. Driveway shall be ~~40~~ **15** foot maximum for one way traffic and ~~24~~ **26** foot maximum for two way traffic.
 - ii. Sidewalk materials and patterning is continuous through driveway.
- h. Garage Entry
 - Permitted on all frontages.
- i. Service Loading
 - ~~Yes.~~ **Permitted.**
- j. Bicycle Parking
 - ~~Yes.~~ **Required.**

8. External Elements

Intent: Guide the integration of external elements into property development including landscaping, utilities and lighting. Refer to Sec. 4.1.4.E, Signage and Sec. 4.1.4.F, Lighting and Noise.

Storefront Signage

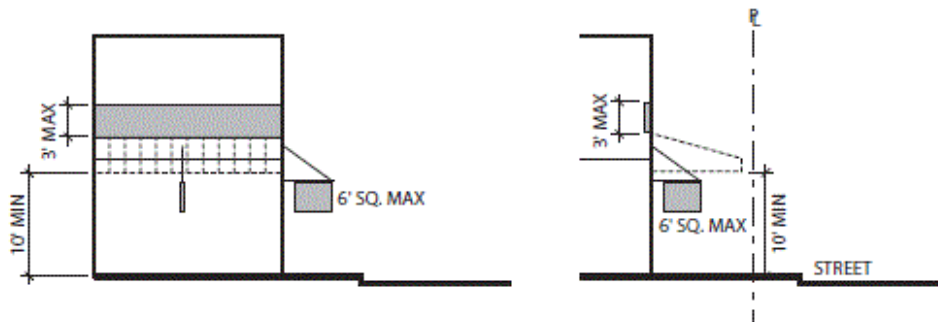

a. Proposed Topography Grades

Provide grading plan with 2 foot contours.

b. Side or Rear Privacy Fence or Wall

Maximum of 8 feet.

c. Front Fence Or Wall

Maximum of 3 feet 6 inches.

d. Landscape Vegetation

i. Minimum of 8 trees (with a 2 inch minimum caliper) per acre of open space.

ii. Trees required for surface parking may be counted **toward overall landscape requirement.**

iii. ~~Maximize shrubs and groundcover per open space.~~

e. Slopes

~~Plant slopes steeper than 3:1 for erosion control.~~

f e. Trash Storage/Recycling, **External Mechanical Units, Electrical Units, and Rain Barrels**

Integrate with building design or screen / conceal from view from public street and riverwalk.

g. ~~External Mechanical Units, Electrical Units and Rain Barrels~~

~~Integrate with building design or screen / conceal from view from public street and riverwalk with no encroachment into setback area.~~

h. ~~Signage~~

~~External band above entry, hanging or blade sign, awning or overhang.~~

i. ~~Lighting Trespass~~

i. ~~Pre-Curfew Limitations for Environmental Zone E4.~~

ii. ~~As Defined by Illuminating Engineers Society of Lighting for Exterior Environment RP-33.~~

~~9. Stormwater Systems~~

~~a. Intent~~

~~Improve water quality in streams and river by reducing stormwater runoff volume, temperature and velocity.~~

~~b. Piped Roof Water~~

~~If a closed drainage system, then no treatment necessary.~~

~~c. Ground Surface Runoff In Areas With Subsoil~~

~~Detain first 0.5 inch rain and percolate into ground, or release within 24 hour minimum and 72 hour maximum.~~

~~d. Ground Surface Runoff In Areas Of Rock and/or Contamination~~

~~Detain first 0.5 inch rain and treat in a stormwater quality structure before discharging to a closed drainage system.~~

40 9. Sustainability

a. Intent

Encourage longevity, durability, energy and economic efficiency as well as improved environmental conditions.

b. Green Building and Landscape

- i. Capable of attaining the **current** Leadership in Energy and Environmental Design (LEED) minimal Performance Level of "Certified."
- ii. Submit completed worksheet of appropriate LEED standard to demonstrate pre-certification estimate.

c. Reflectivity, Heat Island Reduction, Roof and Surface Lots

- i. **Surface lots shall** provide shade and/or use light-colored/high albedo materials with a **solar** reflectance of at least 0.3 **(30%)**.
- ii. Roofs shall use an Energy Star Compliant (highly reflective) ~~and high emissivity roofing (emissivity of at least 0.9)~~ for a minimum of 75% of the roof surface.

4.1.4. General Development Standards

A. Uses

1. Prohibited Uses

Uses not to be established in any district of the Knoxville South Waterfront include all major agriculture, heavy industrial, waste-related services, truck depots, cremation facilities, cemeteries, and storage facilities for Class 1 flammable and combustible liquids (having an aggregate total of more than 100 gallons) but excluding storage that is part of a motorized vehicle or pleasure craft facility.

- a. Heavy industrial includes any use that is potentially dangerous, noxious or offensive to neighboring uses in the district or those who pass on public ways by reason of smoke, odor, noise, glare, fumes, gas, vibration, threat of fire or explosion, emission of particulate matter, interference with radio, television reception, radiation or any other likely cause; heavy industrial asbestos and radioactive materials products; animal processing, packing, treating, and storage, livestock or poultry slaughtering, concentrate plant, processing of food and related products, production of lumber, tobacco, chemical, rubber, leather, clay, bone, paper, pulp, plastic, stone, or glass materials or products, production or fabrication of metals or metal products including enameling and galvanizing, automobile dismantlers and recyclers; batch plant; bulk storage of flammable liquids; chemical, cosmetics, drug, soap, paints, fertilizers and abrasive products; commercial feed lot; concrete batching and asphalt processing and manufacturing, batch plant; earth moving and heavy construction equipment and transportation equipment; explosives; fabricated metal products and machinery; impound lot, wrecker service includes city wreckers, auto storage; leather and leather products includes tanning and finishing; petroleum, liquefied petroleum gas and coal products and refining; primary metal manufacturing; pulp mills; rubber and plastic products, rubber manufacturing; scrap metal processors; saw mill, pulp mill; secondary materials dealers; tire recapping; tobacco products; transportation equipment; wrecking, junk or salvage yard; dredging, earth extraction, clearing or grading (timber cutting); extraction of phosphate or minerals; extraction of sand or

gravel, borrow pit; metal, sand stone, gravel clay, mining and other related processing; stockpiling of sand, gravel, or other aggregate materials; or any similar uses.

- b. Waste-related service includes any use that generally receives solid or liquid wastes from others for transfer to another location, collects sanitary waste or manufactures a product from the composting of organic material. Waste-related service includes the following: animal waste processing, rendering; landfill, incinerator; manufacture and production of goods from composting organic material; outdoor recycle processing center; outdoor storage of recyclable material, including construction material; transfer station; or any similar use.
- c. Major agriculture includes animal raising including horses, hogs, cows, sheep, goats, and swine, poultry, ~~aquaculture~~, dairying, personal or commercial animal breeding and development; floriculture, pasturage, ~~row and field crops~~, ~~viticulture~~, tree or sod farm, silviculture; animal boarding, outdoor; livestock auction; milk processing plant; packing house for fruits or vegetables; plant nursery; plant nursery with landscape supply; retail or wholesale sales of agriculturally-related supplies and equipment; stable; or any similar use. Major Agriculture does not include Urban Agriculture or its subcategories, Personal Garden, Market Garden, or Community Garden.

2. Gated Communities

Private developments such as “gated communities” are prohibited in the Knoxville South Waterfront. They inhibit access to public spaces and create physical and social enclaves. Public rights-of-ways shall remain open, facilitating access to the site and fostering connectivity.

B. Building Envelope and Materials

1. The intent of these standards is to utilize a discipline of form when designing new buildings in order to foster a high quality Knoxville South Waterfront identity.
2. Building walls should reflect and complement the traditional materials and techniques of the Tennessee Valley's regional architecture. They should express the construction techniques and structural constraints of traditional, long-lasting building materials.
 - a. Acceptable building facade materials include: brick and block masonry, glass, wood, stucco, metal panel and native stone. The use of composite or synthetic materials not mentioned above must have equivalent or superior visual and performance properties to those mentioned.
 - b. Windows shall use clear glass with at least 90% light transmission.
 - c. Specialty windows may use stained or opaque glass.
 - d. Detail facades on retail frontages such as storefronts shall have at least 70% glass at the ground level.
 - e. Window openings above the first story shall be at least 25% of the building wall area, with each facade calculated independently.
 - f. Buildings may have flat roofs enclosed by parapets or sloped roofs.
 - g. Flat roofs shall be enclosed with parapets a minimum of 42 inches high or as required to conceal mechanical equipment to the satisfaction of the Knoxville South Waterfront Advisory Committee.
 - h. Balconies, porches, bay windows and other projections are encouraged and may be incorporated into the building setback.

3. Awnings and Canopies

- a. Awnings or canopies shall provide a minimum clearance of 10 feet above the sidewalk and shall have a maximum depth of 6 feet, while maintaining a minimum 2 feet distance from the curb edge.
- b. An awning or canopy may extend into the public right-of-way with the City's Engineer's approval

- 3.4. Requirements of these Form Based Codes apply only where the subject is "clearly visible from the street". The definition of the street includes parks, riverwalks, civic greens, squares and all proposed public areas except alleys. The intention of these parameters are to restrict control to the public realm where it has special significance and limit public preference in the private realm.

C. Frontage Typologies

1. Common Yard

A frontage where the building is setback substantially from the property line. The front yard is visually continuous with adjacent yards.

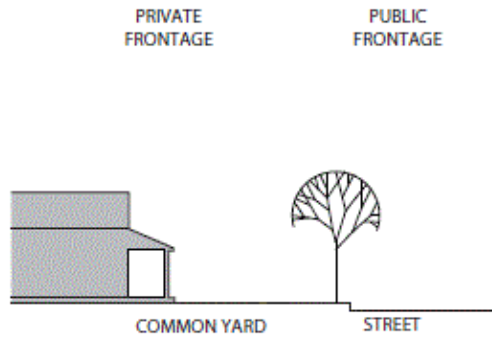

2. Porch and Fence

A frontage type where the building is setback from the property line and the building includes an attached porch. A fence at the property line demarcates the front yard from the street.

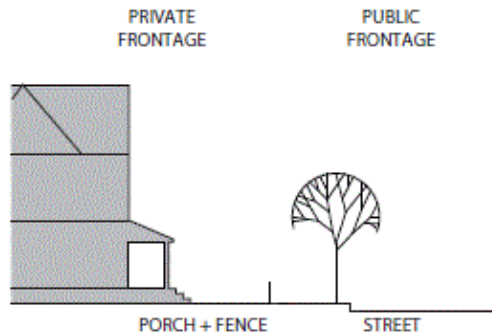

3. Stoop

A frontage type where the raised entry platform is on the principal frontage and the first story is above the level of the ground creating a change in elevation.

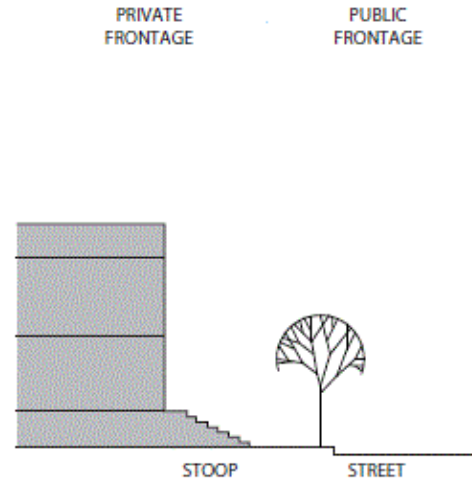

4. Shopfront/Awning

A frontage type where the building meets the property line and a shop-front or awning extends into the setback space.

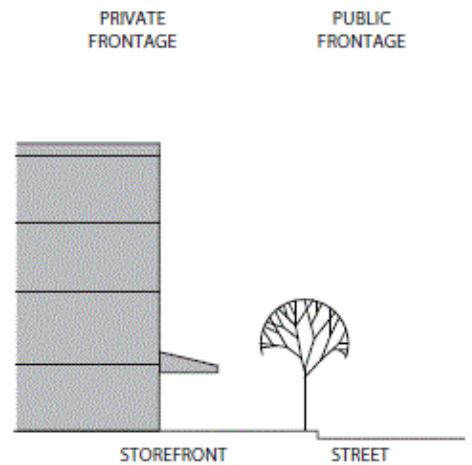

5. Gallery

A frontage type where the building facade is close to the property line and a continuous, covered space is attached to the length of the facade.

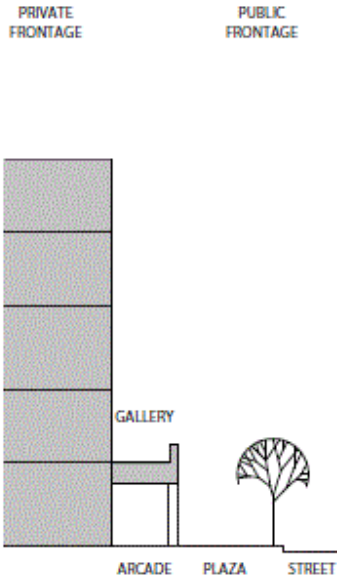

6. Arcade

A frontage type where the building facade is close to the property line and the ground floor is recessed from the building facade to allow for a continuous, covered passageway.

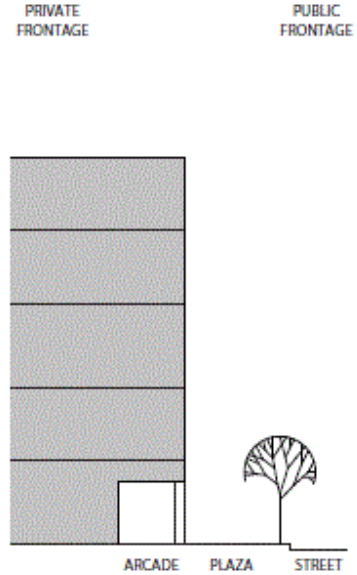

D. Off Street Parking and Loading

1. Surface Parking

Vision: Avoid large, unbroken expanses of pavement. Divide large parking lots into smaller paved areas that are separated by landscaping, access driveways or ancillary structures. Parking lots shall include parking islands to breakdown the scale of the surface lot, with the inclusion of pedestrian-scale lighting in lieu of standard lot lighting.

a. Parking shall be placed behind the buildings, but ~~where accommodation of the minimum parking requirements are not adequately met~~, parking on the side of buildings is acceptable provided that the parking is screened from view from any adjoining right-of-way. On street parking available along the frontage lines that correspond to each lot shall be counted toward the parking requirement for the parcel. By exemption, the required parking may be provided within a 5 minute (1/4 mile) walking radius of the site which it serves.

~~b. Avoid large, unbroken expanses of pavement. Divide large parking lots into smaller paved areas that are separated by landscaping, access driveways or ancillary structures. Parking lots shall include parking islands to breakdown the scale of the surface lot, with the inclusion of pedestrian-scale lighting in lieu of standard lot lighting.~~ A visual buffer of landscaping shall be provided towards adjacent properties. Any parking lot adjoining a public street shall be screened from view to a height of 3 feet by walls, berms or landscaping or a combination of these 3. If landscaping is used, the planting bed shall be a minimum of 10 feet wide. Separate parking areas from buildings by use of a raised walkway or planting strip. Avoid directly abutting parking aisles or spaces to the edge of a building.

c. One bicycle rack space shall be provided for every 10 vehicular parking spaces.

2. Structured Parking

a. **Vision:** Future parking structures in the Knoxville South Waterfront should be constructed with the understanding that required parking spaces for an area should be shared over the course of a day to maximize efficiency. While the construction of new parking garages will be critical to accommodate future vehicles in the study area, it is important to establish parking ratios that promote the use of public transportation and encourage development that generates less traffic. New parking facilities must be designed in such a way that does not adversely affect their surroundings.

b. Monotonous and unadorned parking structure elevations are prohibited. No blank walls or exposed parking levels should face directly onto primary streets. Attempts should be made to reduce the overall visual mass of the parking garage through the architectural expression of stair towers, canopies and screening devices. Parking garage elevations shall be screened from view with the incorporation of lightweight design elements that add visual interest to the elevations (such as trellis panels) and filter the view to parked cars. When possible, building edges that face primary streets should incorporate programmable spaces into the ground floor of the parking structure (such as small commercial/retail uses) to activate the street edge. Garage entries shall not exceed 16 foot clear height and 24 26 foot clear width. Provisions shall be made for audible and visible warnings at garage exits to protect pedestrians from vehicles.

3. Service Loading

Curb cuts and service roads leading to service areas shall be located as far away as possible from public entrances. Service areas to buildings shall be screened from view by plantings or low walls.

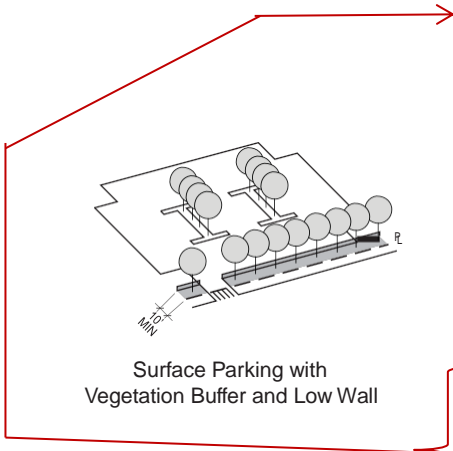

Surface Parking with Vegetation Buffer and Low Wall

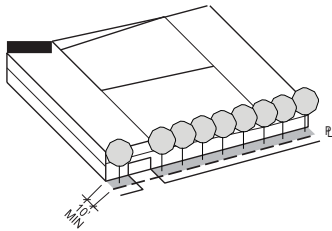

Structured Parking with Vegetation Buffer

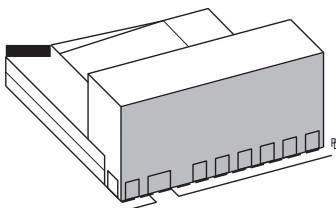

Structured Parking with Building Buffer

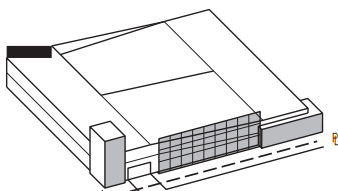

Structured Parking with Screening

E. Signage

Knoxville's Signage Ordinance shall apply.

Signage within the Knoxville South Waterfront should be clear, informative and durable. Appropriate signage is important for commercial uses that need to effectively advertise their goods and services. Inappropriate advertising signage contributes to visual clutter of the environment by their design, location, material choice or obtrusive size. Primary concerns regarding signage revolve around the sign's location, size, material and illumination.

1. SW1

The sign regulations of Article 5, Section 10C, Residential Districts, shall apply in the SW1 District.

2. SW2 through SW7

a. Sign Area

The total allocated sign area shall not exceed one square foot per linear foot of building frontage per principal building. Except for arcade and hanging signs and window signs, the combination of all other permitted sign types shall not exceed the maximum allocated sign area for the building.

b. Permitted Sign Types

The following types of signs shall be permitted.

i. Storefront Signage

a). Arcade and Hanging Signs

- 1) Arcade or hanging signs shall provide a minimum clearance of 8 feet above the sidewalk.
- 2) The maximum sign area shall not exceed 6 square feet per arcade or hanging sign.

b). Awning and Canopy Signs

~~1) Awnings or canopies shall provide a minimum clearance of 10 feet above the sidewalk and shall have a minimum depth of 6 feet. An awning or canopy may extend into the public right-of-way with the City's Engineer's approval.~~

2) The maximum sign area shall not exceed 6 square feet per awning or canopy.

c). Projecting Signs

- 1) Projecting signs shall provide a minimum clearance of 8 feet above the sidewalk and shall extend no more than 4 feet from the facade of a building. A projecting sign may extend into the public right-of-way with the City's **Law Department Engineer's** approval.
- 2) When placed at the ground story level, projecting signs shall not exceed 6 feet in area. When placed at the second story level, projecting signs shall not exceed 12 square feet in area. When placed at the third story level, projecting signs shall not exceed 18 square feet in area. Projecting signs on the third story level are only permitted on the corner of a block, where they may project from a building corner.

3) No sign shall protrude to within 2 feet of the curb edge, if less than 14 feet above the sidewalk.

d). Window Signs

Window signs shall not collectively exceed 10% of the window area on each façade

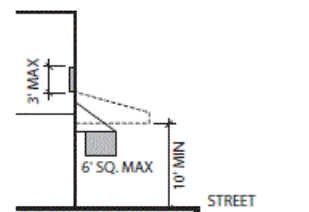
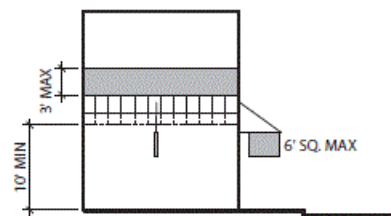

Storefront Signage

ii. Wall Signage

- a). Wall signs are permitted within the area between the bottom of the second story windows and the top of first floor windows within a horizontal band not to exceed 3 feet in height. In no case shall this band be higher than 18 feet or lower than 12 feet above the adjacent sidewalk.
- b). Wall signs are also permitted immediately below the roof line of the building or structure and shall not extend more than 30% of the width of the building facade. Wall signs shall not project above the elevation of any building or structure.
- c). A wall sign may extend up to 12 inches into a public right-of-way.

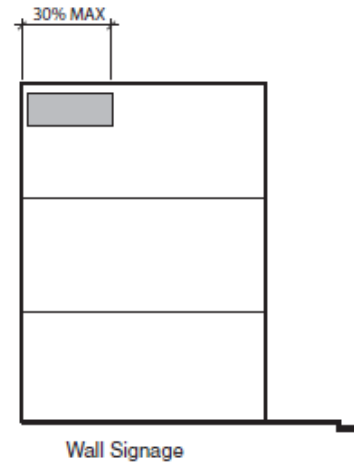

iii. Roof Signage

Roof Signs are discouraged in the Knoxville South Waterfront. Roof signs will be included in the overall calculation of building height.

c. Sign Illumination

- i. Signs may be illuminated from within or from an external source, but such illumination shall be in a manner that avoids glare or reflection which in any way interferes with traffic safety.
- ii. Internally illuminated signs shall be designed with:
 - a). Individually illuminated letters;
 - b). An opaque background; or
 - c). The background of the sign face having a darker color than the content or message of the sign.
- iii. Neon or any similar exposed tube lighting is permitted provided that such lighting shall not be used solely to outline the perimeter of the sign face or sign structure, ~~or outline or highlight architectural features on a building or structure.~~

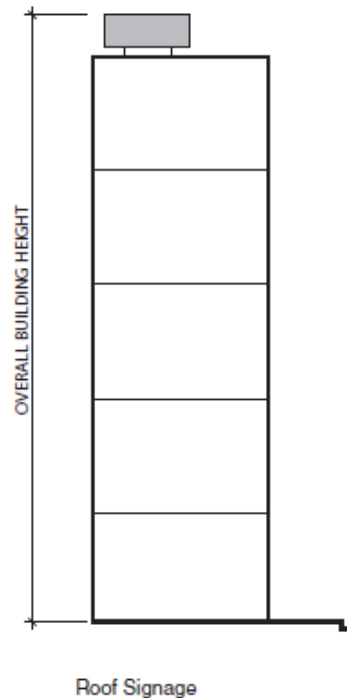

d. Street Addresses

The street number of the business is not required on each sign, provided that the street number is placed on each entry door or within 3 feet of the door.

Engineering Society of North America's (IESNA) publications. Refer to each District Standard for the relevant Environmental Zone designation.

F. Lighting and Noise

1. External Lighting Standards

a. ~~Intent~~ **Intent Illuminance/Light Trespass**

The intent of the outdoor lighting standards are to:

- i. Provide adequate light for safety and security,
- ii. Promote efficient and cost effective lighting and to conserve energy,
- iii. ~~Reduce~~ **Minimize** light pollution, light trespass, glare, and offensive light sources,
- iv. ~~Reduce sky glow to increase night sky access,~~
- v **iv.** ~~Reduce~~ **Minimize** development impact on nocturnal environments,
- vi **v.** Prevent inappropriate, poorly designed or **poorly** installed outdoor lighting,
- vii **vi.** Encourage quality lighting design; light fixture shielding, uniformity ratios and establish maximum light levels within and on property lines.

~~b. Illuminance~~

~~Meet and maintain the recommended illuminance range and uniformity for each use and/or structure specified in the latest issue of the Illuminating Engineering Society of North America's (IESNA) publications including but not limited to:~~

- ~~i. car dealerships,~~
- ~~ii. service stations,~~
- ~~iii. buildings and monuments,~~
- ~~iv. intersections,~~
- ~~v. outdoor merchandising,~~
- ~~vi. parking facilities,~~
- ~~vii. pedestrian ways,~~
- ~~viii. walkways/bikeways,~~
- ~~ix. roadways,~~
- ~~x. security locations/tasks.~~

~~c. Light Trespass~~

~~Meet and maintain the recommended illuminance range to minimize light trespass as specified in the latest issue of Illuminating~~

~~d b.~~ **Light Colors**

Yellow spectrum lamps such as sodium lamps are permitted only within City right-of-ways and prohibited on private property.

~~e c.~~ **Controls**

Use and maintain automated external lighting controls to minimize light pollution and energy consumption. Such controls include but are not limited to:

- i. time clocks and/or dimmers,
- ii. motion and/or light sensors,
- iii. phased switching of multiple circuits.

~~f d.~~ **Prohibitions**

No person shall install any of the following types of outdoor lighting fixtures:

- i. Blinking, flashing, moving, revolving, flickering, changing intensity or color, and chase lighting, except for temporary seasonal displays or for public safety.
- ii. Any light fixture that may be confused with or construed as a traffic control device.
- iii. **Neon or any similar exposed tube lighting is prohibited to outline or highlight architectural features on a building or structure**

~~g e.~~ **Exceptions**

The standards of this Section shall not apply to the following types of exterior lighting:

- i. Landmark Signs: Illumination of cultural significant signs designated by the community as a landmark.
- ii. Ornamental Lighting: Low voltage (12 volts or less), low wattage ornamental landscape lighting fixtures, and solar operated light fixtures having self-contained rechargeable batteries, where any single light fixture does not exceed 100 lumens.
- iii. Strings of Light: Strings of light, not exceeding a maximum of 50 lumens per lamp (equivalent of a 7 watt C7 incandescent light bulb) on properties that are used exclusively for residential uses.

- iv. River Navigation Lighting: Lighting used exclusively for river navigation and safety purposes.
- v. Right of Way Lighting: Public lighting that is located within the right of way on State or Federal controlled land.
- vi. Seasonal Lighting Displays: Lighting displays from November 15 through January 30 of the following year.
- vii. Temporary Events: Temporary outdoor activities that include, without limitation, fairs, carnivals, sporting events, concerts, and promotional activities that require temporary outdoor lighting.

2. Noise

Knoxville's Noise Ordinance shall apply.

4.1.5. Streetscape Standards



A. Vision and Intent

Streetscapes are the areas between buildings that are occupied by the public street right-of-way and related street, sidewalk, and landscaping improvements. Streetscapes are among the most important urban design features because their appearance, character and the impressions they evoke create the public image of the Knoxville South Waterfront. That image is significant to how residents and visitors think and feel about the City. The standards establish appropriate requirements for the width and uses of public and private street rights-of-way (for traffic, parking, pedestrians, bicycles, and landscaping). The following standards apply to the design and construction of public rights-of-way and right-of-way improvements in conjunction with proposed subdivisions, individual lot development where proposed projects are required to provide right-of-way dedications or improvements designed and constructed by the City of Knoxville.

Location and provision of some or all streetscape elements is subject to detailed design.

B. Path, P-20-12

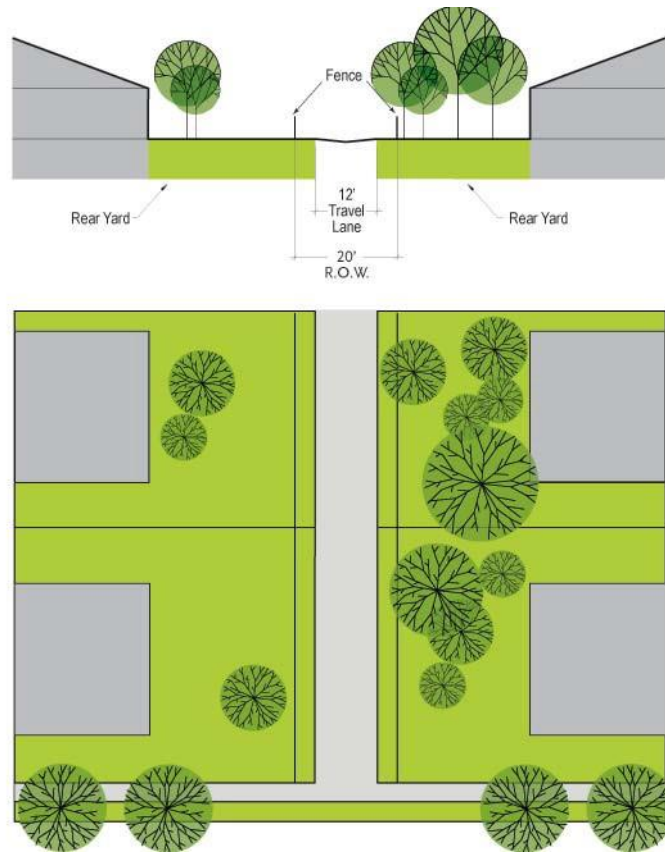

Thoroughfare Type		Path, P-20-12
Right-of-Way Width	20'	
Pavement Width	12'	
Movement	One way	
Design Speeds	10 mph	
Pedestrian Crossing Time	3.5 seconds	
Traffic Lanes	NA	
Parking Lanes	NA	
Bike Lanes	NA	
Curb Radius	15'	
Walkway Type	Path	
Planter Type	None	
Curb Type	Inverted curb	
Landscape Type	NA	
Transportation Provision	NA	
Utilities	All underground	

Key		RA 20 -12 -PL
Thoroughfare Type		RA
Right of Way Width		20
Pavement Width		-12
Transportation		-PL

Thoroughfare Types	
Rear Alley	RA
Street	ST
Side Road	SR
Commercial Street	CS
Transportation Types	
Parking Lane(s)	PL / 2PL
Bike Lane(s)	BL / 2PL

C. Rear Alley, RA-20-12

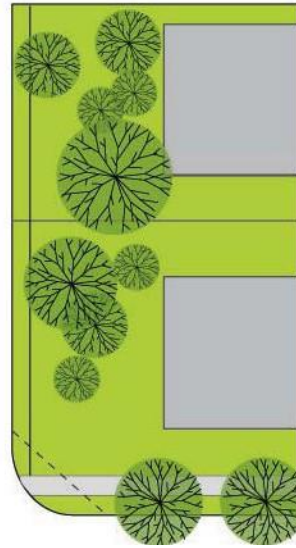
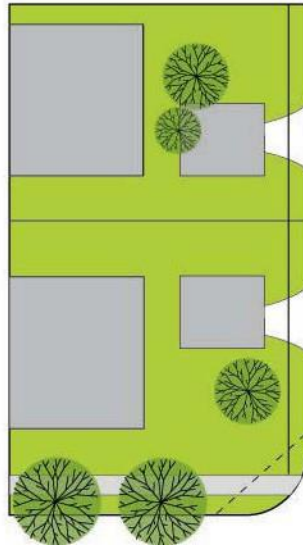
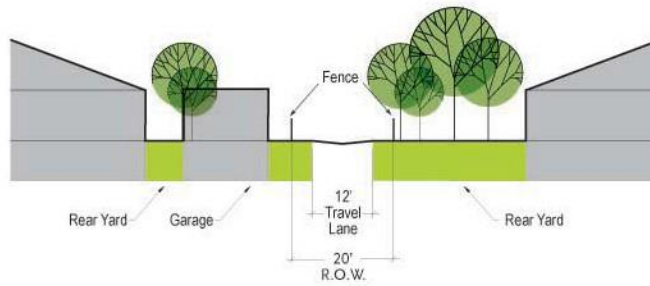

Thoroughfare Type	Rear Alley, RA 20-12
Right-of-Way Width	20'
Pavement Width	12'
Movement	One way
Design Speeds	10 mph
Pedestrian Crossing Time	3.5 seconds
Traffic Lanes	1 lane
Parking Lanes	NA
Bike Lanes	NA
Curb Radius	25'
Walkway Type	None
Planter Type	None
Curb Type	Inverted crown
Landscape Type	NA
Transportation Provision	NA
Utilities	All underground

Key	RA 20-12-PL
Thoroughfare Type	RA
Right of Way Width	20
Pavement Width	12
Transportation	PL

Thoroughfare Types	
Rear Alley	RA
Street	ST
Side Road	SR
Commercial Street	CS
Transportation Types	
Parking Lane(s)	PL / 2PL
Bike Lane(s)	BL / 2PL

D. Street, ST-42-24-PL

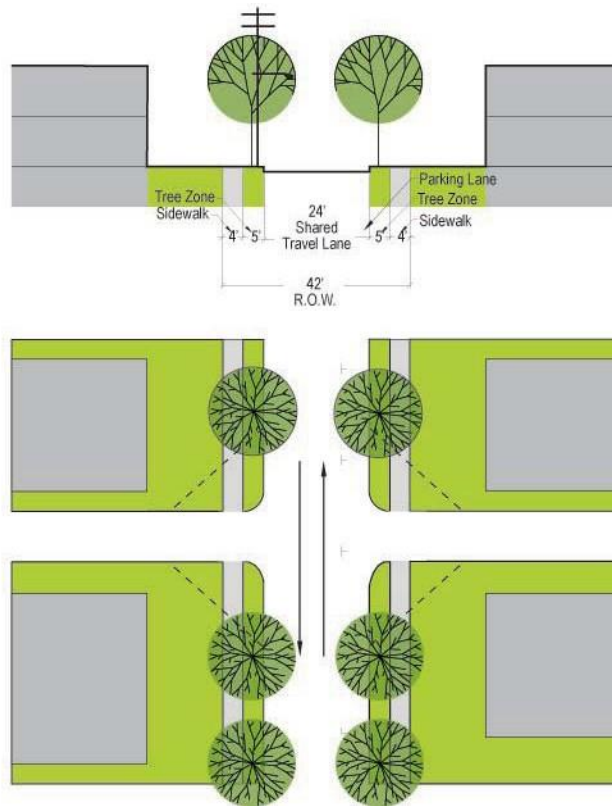

Thoroughfare Type	Street, ST-42-24-PL
Right-of-Way Width	42'
Pavement Width	24'
Movement	Yield movement
Design Speeds	25 mph
Pedestrian Crossing Time	6.9 seconds
Traffic Lanes	2 lanes, 1 shared lane at parked vehicles
Parking Lanes	1 side, unmarked
Bike Lanes	NA, bike share road
Curb Radius	15'
Walkway Type	5' sidewalk
Planter Type	5' continuous planter
Curb Type	Curb
Landscape Type	Trees @ 30' O.C.
Transportation Provision	NA
Utilities	Overhead power, cable, phone

Key	RA	20	-12	-PL
Thoroughfare Type	RA	20	-12	-PL
Right of Way Width	RA	20	-12	-PL
Pavement Width	RA	20	-12	-PL
Transportation	RA	20	-12	-PL

Thoroughfare Types	
Rear Alley	RA
Street	ST
Side Road	SR
Commercial Street	CS
Transportation Types	
Parking Lane(s)	PL / 2PL
Bike Lane(s)	BL / 2PL

E. Street, ST-50-30-2PL

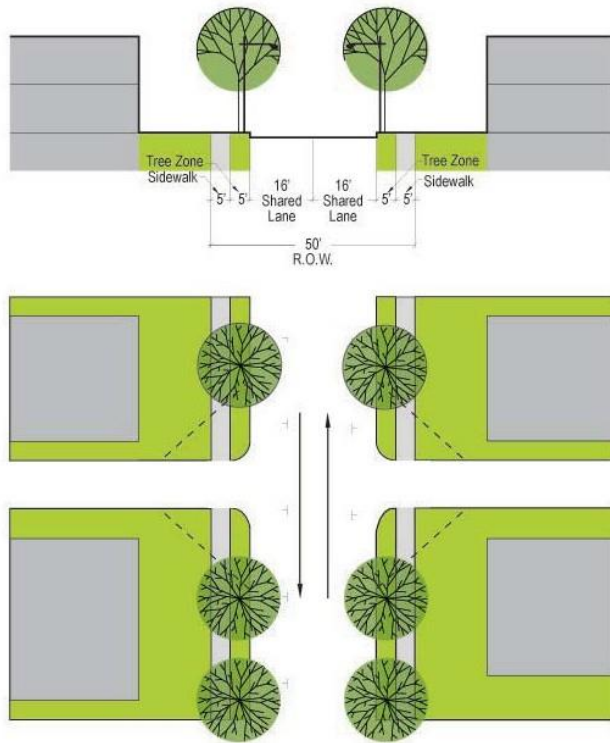

Thoroughfare Type	Street, ST-50-30-2PL
Right-of-Way Width	50'
Pavement Width	30'
Movement	Yield movement
Design Speeds	25 mph
Pedestrian Crossing Time	8.6 seconds
Traffic Lanes	2 lanes, 1 shared lane at parked vehicles
Parking Lanes	Both sides unmarked
Bike Lanes	NA, bike share road
Curb Radius	15'
Walkway Type	5' sidewalk
Planter Type	5' continuous planter
Curb Type	Curb
Landscape Type	Trees @ 30' O.C.
Transportation Provision	NA
Utilities	Overhead power, cable, phone

Key	RA	20	-12	-PL
Thoroughfare Type				
Right of Way Width				
Pavement Width				
Transportation				

Thoroughfare Types	
Rear Alley	RA
Street	ST
Side Road	SR
Commercial Street	CS
Transportation Types	
Parking Lane(s)	PL / 2PL
Bike Lane(s)	BL / 2PL

F. Street, ST-50-30-PL

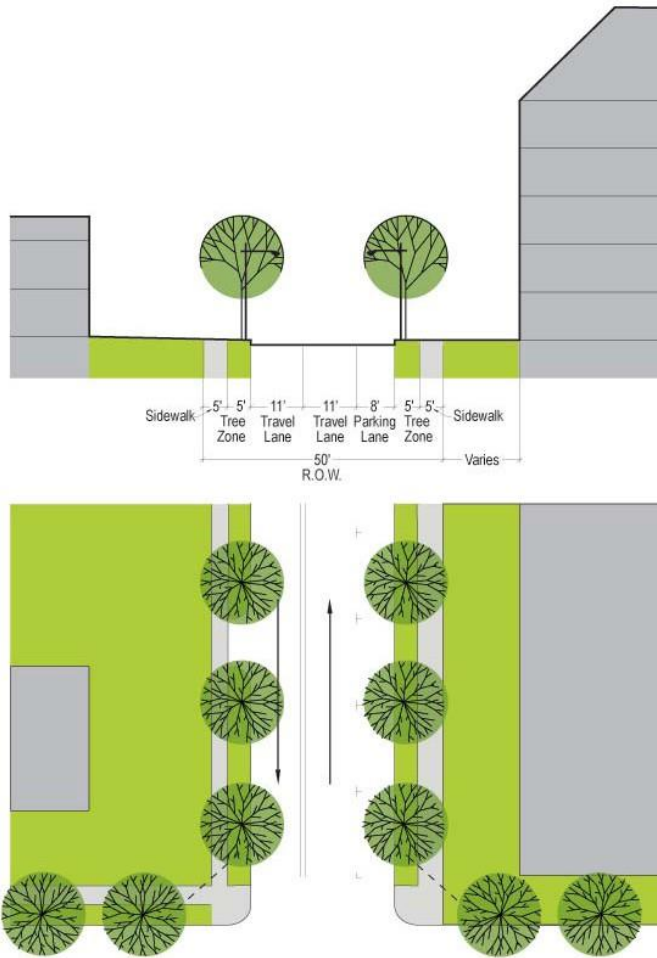

Thoroughfare Type		Street, ST-50-30-PL
Right-of-Way Width		50'
Pavement Width		30'
Movement		Slow movement
Design Speeds		25 mph
Pedestrian Crossing Time		8.6 seconds
Traffic Lanes		2 lanes
Parking Lanes		One side @ 8' marked
Bike Lanes		NA, bike share road
Curb Radius		15'
Walkway Type		5' sidewalk
Planter Type		5' continuous planter
Curb Type		Curb or swale
Landscape Type		Trees @ 30' O.C.
Transportation Provision		NA
Utilities		Overhead power, cable, phone

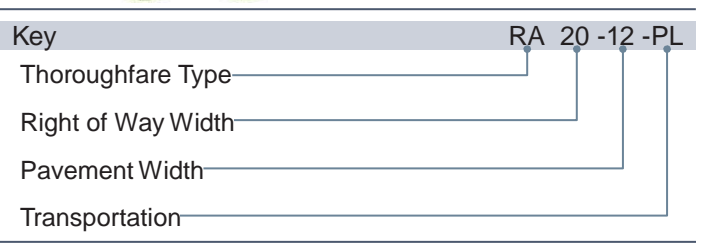

Thoroughfare Types	
Rear Alley	RA
Street	ST
Side Road	SR
Commercial Street	CS
Transportation Types	
Parking Lane(s)	PL / 2PL
Bike Lane(s)	BL / 2PL

G. Side Road, SR-56-36-2PL

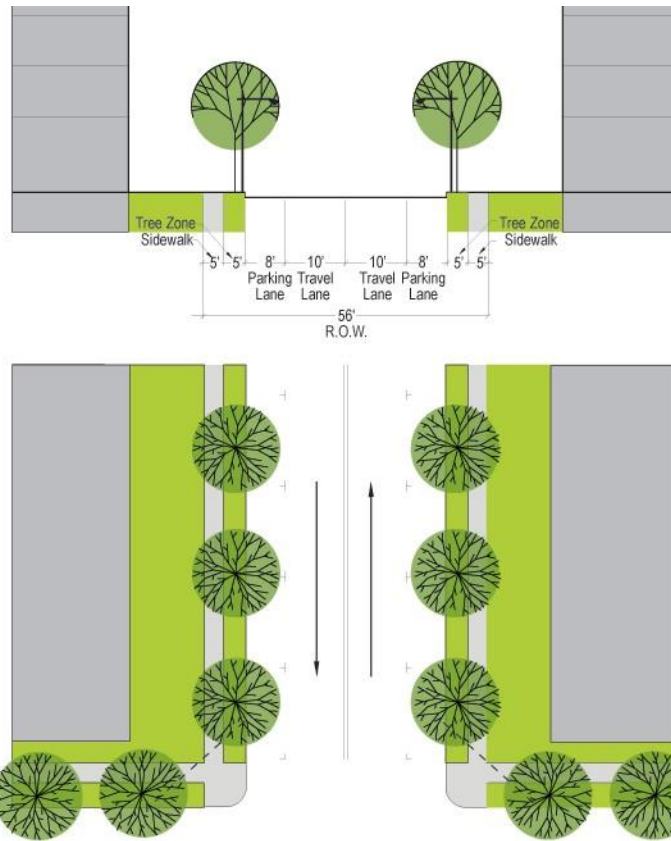

Thoroughfare Type	Side Road, SR-56-36-2PL
Right-of-Way Width	56'
Pavement Width	36'
Movement	Slow movement
Design Speeds	20 mph
Pedestrian Crossing Time	10.3 seconds
Traffic Lanes	2 lanes
Parking Lanes	Both sides @ 8' marked
Bike Lanes	NA
Curb Radius	15'
Walkway Type	5' sidewalk
Planter Type	5' Continuous planter
Curb Type	Curb or swale
Landscape Type	Trees @ 30' O.C.
Transportation Provision	NA
Utilities	All underground

Key	RA 20 -12 -PL
Thoroughfare Type	RA
Right of Way Width	20
Pavement Width	-12
Transportation	-PL

Thoroughfare Types	
Rear Alley	RA
Street	ST
Side Road	SR
Commercial Street	CS
Transportation Types	
Parking Lane(s)	PL / 2PL
Bike Lane(s)	BL / 2PL

H. Street, ST-70-40-PL-2BL

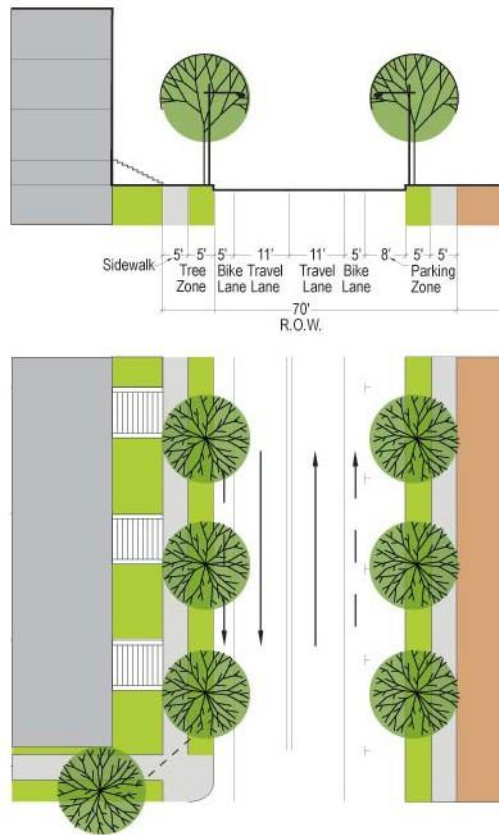

Thoroughfare Type	Street, ST-70-40-PL-2BL
Right-of-Way Width	70'
Pavement Width	40'
Movement	Free movement
Design Speeds	30-35 mph
Pedestrian Crossing Time	11.4 seconds
Traffic Lanes	2 lanes
Parking Lanes	One side @ 8' marked
Bike Lanes	Both sides @ 5' marked
Curb Radius	15'
Walkway Type	5' sidewalk
Planter Type	5' continuous planter
Curb Type	Curb or swale
Landscape Type	Trees @ 30' O.C.
Transportation Provision	NA
Utilities	All underground

Key	RA	20	-12	-PL
Thoroughfare Type	RA	20	-12	-PL
Right of Way Width	RA	20	-12	-PL
Pavement Width	RA	20	-12	-PL
Transportation	RA	20	-12	-PL

Thoroughfare Types	
Rear Alley	RA
Street	ST
Side Road	SR
Commercial Street	CS
Transportation Types	
Parking Lane(s)	PL / 2PL
Bike Lane(s)	BL / 2PL

I. Commercial Street, CS-58-38-2PL-BR

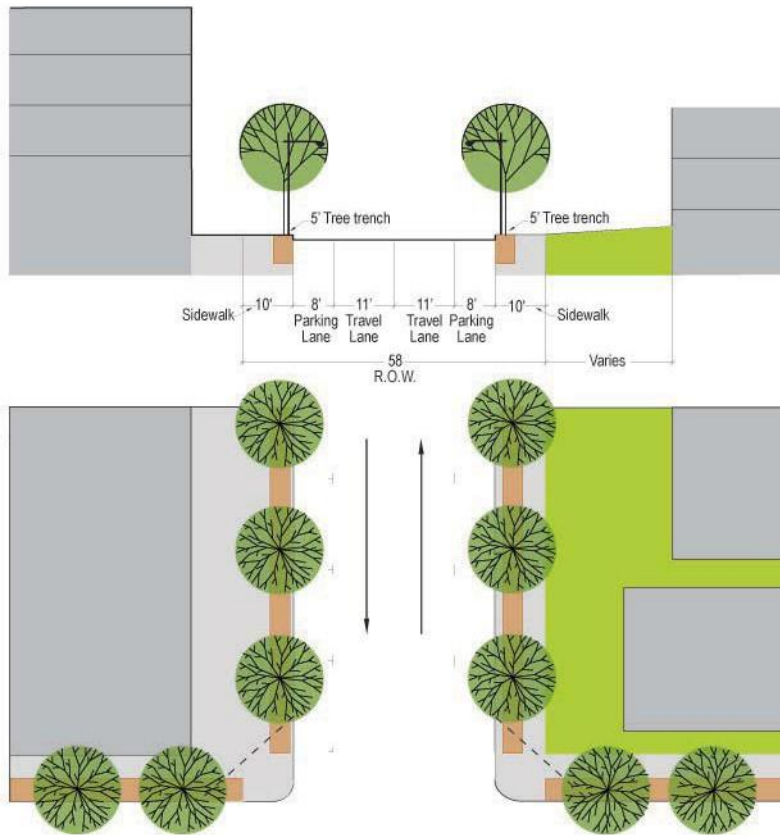

Thoroughfare Type		Commercial Street, CS-58-38-2PL-BR
Right-of-Way Width		58'
Pavement Width		38'
Movement		Slow movement
Design Speeds		25 mph
Pedestrian Crossing Time		10.3 seconds
Traffic Lanes		2 lanes
Parking Lanes		Both sides @ 8' marked
Bike Lanes		NA
Curb Radius		15'
Walkway Type		10' sidewalk
Planter Type		5' continuous trench
Curb Type		Curb
Landscape Type		Trees @ 30' O.C.
Transportation Provision		Bus route
Utilities		All underground

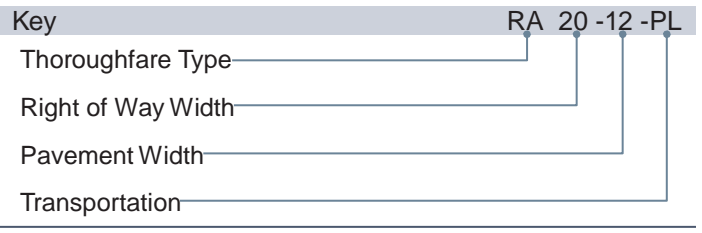

Thoroughfare Types	
Rear Alley	RA
Street	ST
Side Road	SR
Commercial Street	CS
Transportation Types	
Parking Lane(s)	PL / 2PL
Bike Lane(s)	BL / 2PL

J. Street, ST-52-22-BR

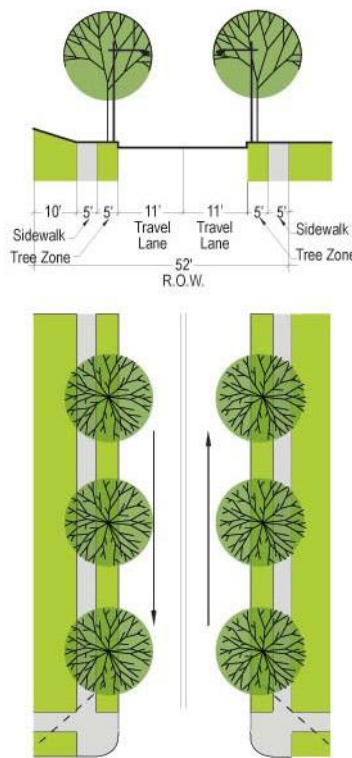

Thoroughfare Type	Street, ST-52-22-BR
Right-of-Way Width	52'
Pavement Width	22'
Movement	Slow movement
Design Speeds	25 mph
Pedestrian Crossing Time	6.9 seconds
Traffic Lanes	2 lanes
Parking Lanes	NA
Bike Lanes	NA
Curb Radius	15'
Walkway Type	5' sidewalk
Planter Type	5' continuous planter
Curb Type	Curb or swale
Landscape Type	Trees @ 30' O.C.
Transportation Provision	Bus route
Utilities	Overhead power, cable, phone

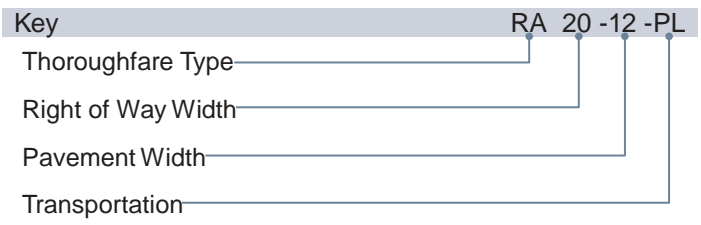

Thoroughfare Types	
Rear Alley	RA
Street	ST
Side Road	SR
Commercial Street	CS
Transportation Types	
Parking Lane(s)	PL / 2PL
Bike Lane(s)	BL / 2PL

K. Boulevard, BLVD-70-50-1-PL-2BL-BR

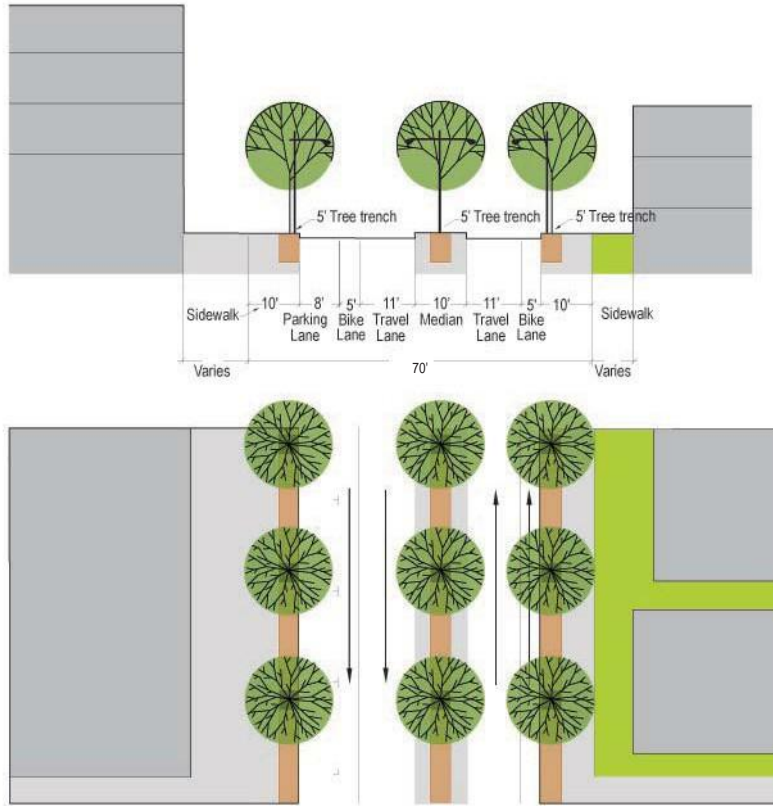

Thoroughfare Type	Boulevard, BLVD-70-50-1PL-2BL-BR
Right-of-Way Width	70'
Pavement Width	50'
Movement	Slow movement
Design Speeds	25 mph
Pedestrian Crossing Time	10.3 seconds
Traffic Lanes	2 lanes
Parking Lanes	1 Side @ 8' marked
Bike Lanes	Both Sides @ 5' marked
Curb Radius	15'
Walkway Type	10' sidewalk
Planter Type	5' continuous trench
Curb Type	Curb
Landscape Type	Trees @ 30' O.C.
Transportation Provision	Bus route
Utilities	All underground

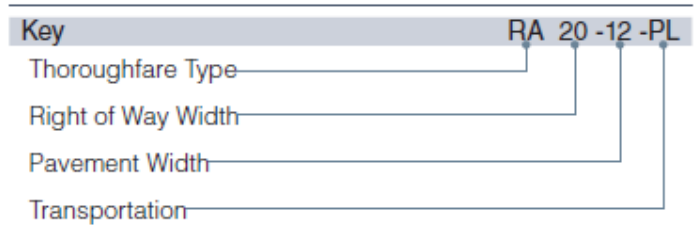

Thoroughfare Types	
Rear Alley	RA
Street	ST
Side Road	SR
Commercial Street	CS
Transportation Types	
Parking Lane(s)	PL / 2PL
Bike Lane(s)	BL / 2PL

L. Street: ST-62-38-2PL

Waterfront Drive: Barber Street to Foggy Bottom Street

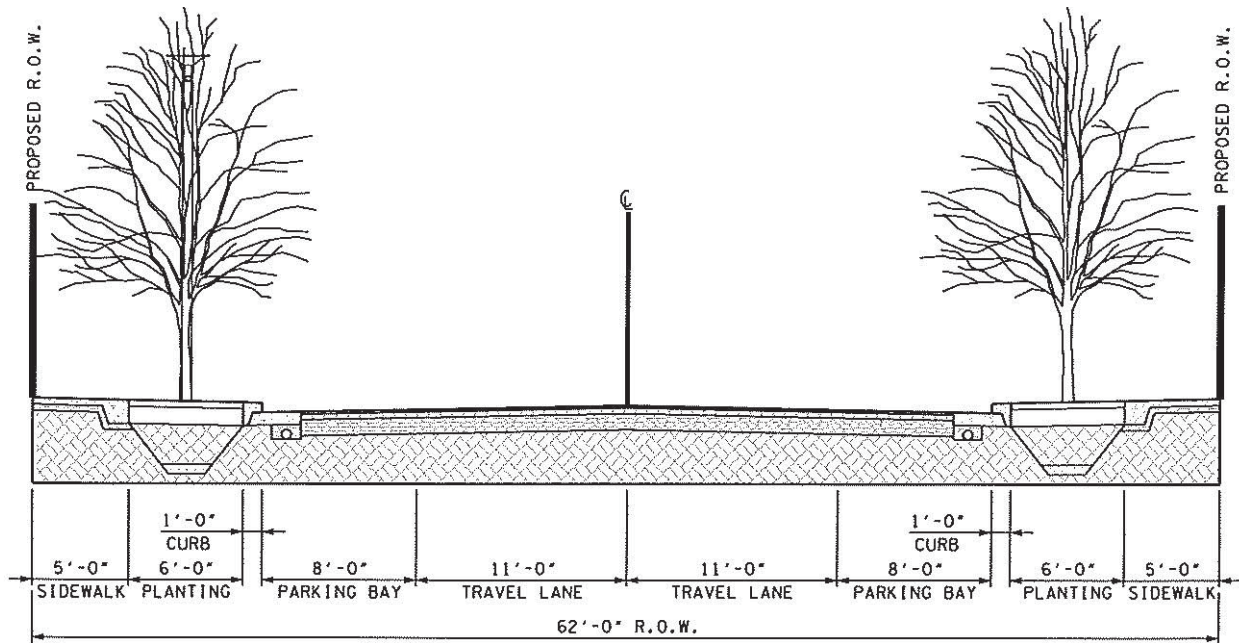

RIVER ROAD (62' PUBLIC R.O.W.)
LOOKING EAST

Thoroughfare Type	Street, ST-62-38-2PL
Right-of-Way Width	62'
Pavement Width	38'
Movement	Slow movement
Design Speeds	25 mph
Pedestrian Crossing Time	6.3 seconds
Traffic Lanes	2 lanes
Parking Lanes	Both sides @ 8' marked
Bike Lanes	NA
Curb Radius	15' (except @ Barber which is 25')
Walkway Type	5' sidewalk
Planter Type	6' wide treatment planter
Curb Type	1'
Landscape Type	Trees @ 30'-35' O.C.
Transportation Provision	Trolleys
Utilities	All underground

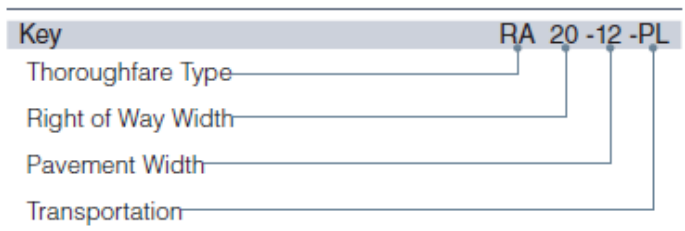

Thoroughfare Types	
Rear Alley	RA
Street	ST
Side Road	SR
Commercial Street	CS
Transportation Types	
Parking Lane(s)	PL / 2PL
Bike Lane(s)	BL / 2PL

M. Street: ST-58-36-2PL

Langford Avenue: Barber Street to Empire Street

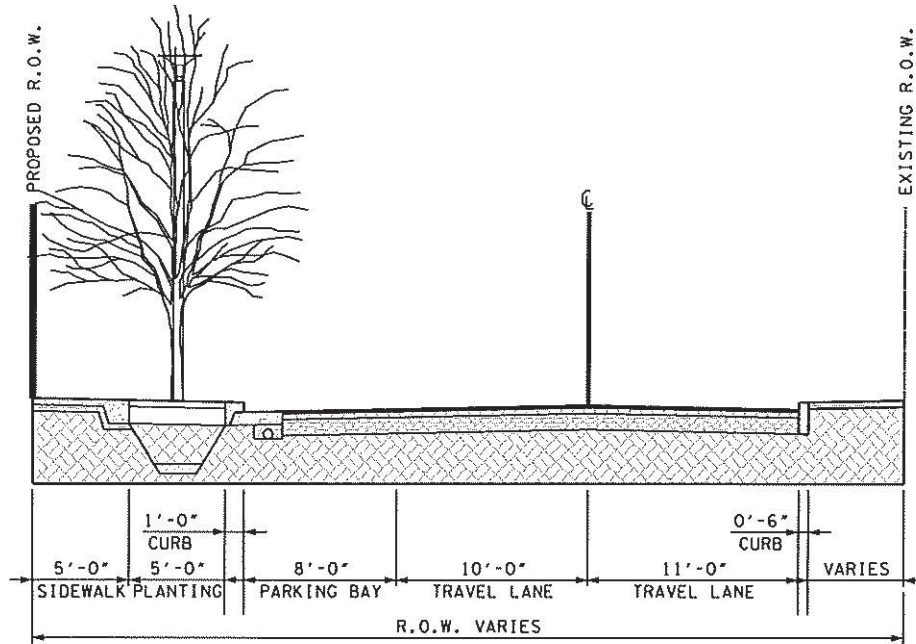

LANGFORD AVENUE (PUBLIC R.O.W. VARIES)
LOOKING EAST

Thoroughfare Type	Street, ST-58-36-2PL
Right-of-Way Width	58'
Pavement Width	36'
Movement	Slow movement
Design Speeds	25 mph
Pedestrian Crossing Time	5.8 seconds
Traffic Lanes	2 lanes
Parking Lanes	Both sides @ 8' marked
Bike Lanes	NA
Curb Radius	15'
Walkway Type	5' sidewalk
Planter Type	5' wide treatment planter
Curb Type	1'
Landscape Type	Trees @ 30'-35' O.C.
Transportation Provision	NA
Utilities	All underground

Key	RA 20 -12 -PL
Thoroughfare Type	RA
Right of Way Width	20
Pavement Width	-12
Transportation	-PL

Thoroughfare Types	
Rear Alley	RA
Street	ST
Side Road	SR
Commercial Street	CS
Transportation Types	
Parking Lane(s)	PL / 2PL
Bike Lane(s)	BL / 2PL

**Note: Only north side of Langford to be improved

N. ST-68-46-2PL-2BL

Sevier Avenue: Dixie Street to Foggy Bottom Street

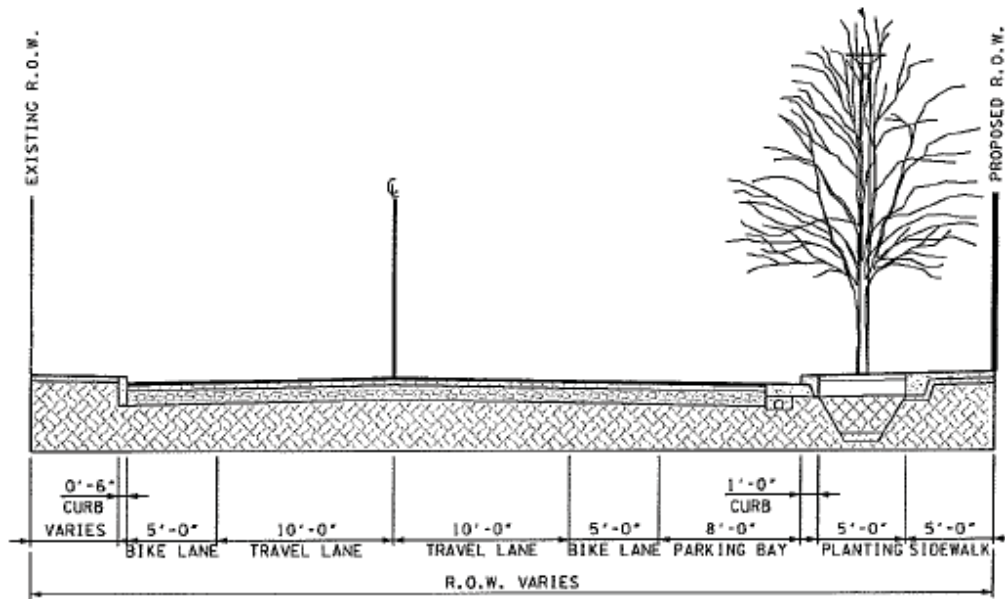

SEVIER AVENUE (PUBLIC R.O.W. VARIES)
LOOKING EAST

Thoroughfare Type	Street, ST-68-46-2PL-2BL
Right-of-Way Width	68'
Pavement Width	46'
Movement	Free movement
Design Speeds	35 mph
Pedestrian Crossing Time	8.6 seconds
Traffic Lanes	2 lanes
Parking Lanes	Both sides @ 8' marked
Bike Lanes	Both sides @ 5' marked
Curb Radius	15'
Walkway Type	5' sidewalk
Planter Type	5' wide treatment planter
Curb Type	1'
Landscape Type	Trees @ 30'-35' O.C.
Transportation Provision	Trolleys
Utilities	All underground

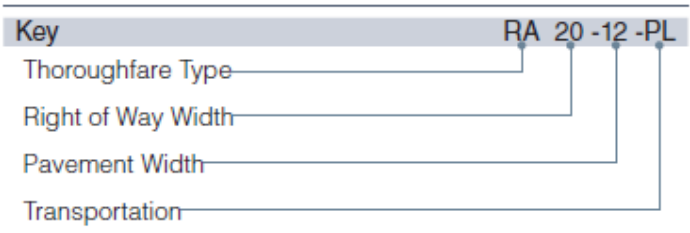

Thoroughfare Types	
Rear Alley	RA
Street	ST
Side Road	SR
Commercial Street	CS
Transportation Types	
Parking Lane(s)	PL / 2PL
Bike Lane(s)	BL / 2PL

O. Street: ST-60-38-2PL

Barber Street: Sevier Avenue to Phillips Street, Langford Avenue to River

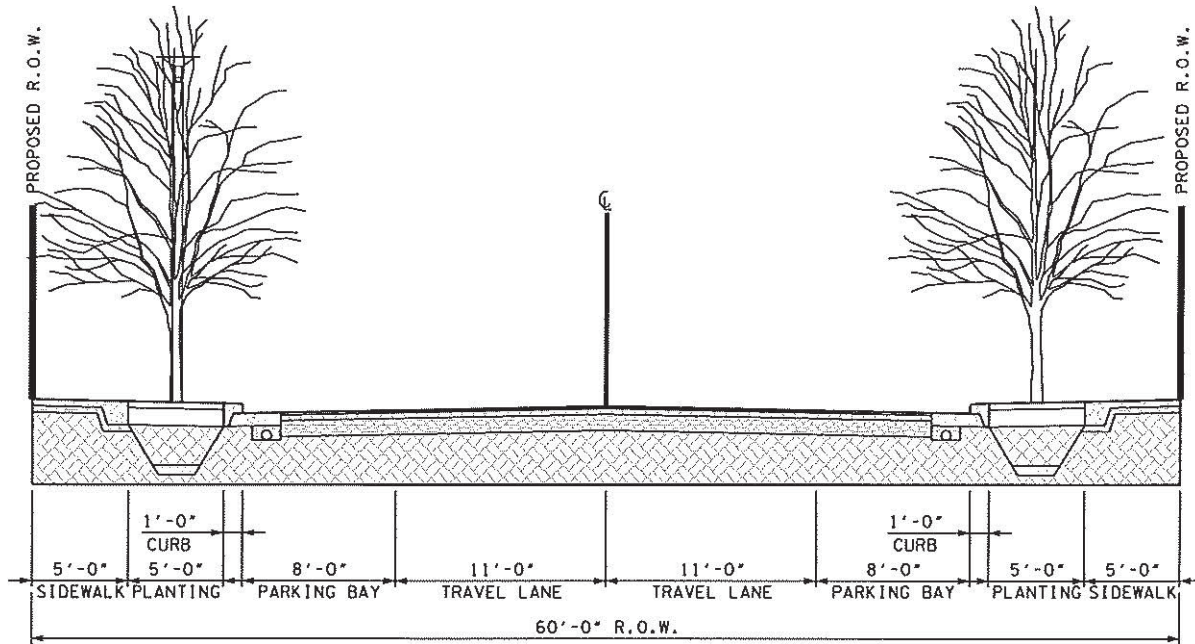

BARBER STREET (60' PUBLIC R.O.W.)
SEVIER TO PHILLIPS
LANGFORD TO RIVER ROAD
LOOKING SOUTH

Thoroughfare Type	Street, ST-60-38-2PL
Right-of-Way Width	60'
Pavement Width	38'
Movement	Slow movement
Design Speeds	25 mph
Pedestrian Crossing Time	6.3 seconds
Traffic Lanes	2 lanes
Parking Lanes	Both sides @ 8' marked
Bike Lanes	NA
Curb Radius	15' (25' @ Sevier Ave & River Rd)
Walkway Type	5' sidewalk
Planter Type	Upland ot treatment planter, width varies
Curb Type	1'
Landscape Type	Tree spacing varies
Transportation Provision	Trolleys
Utilities	All underground

Key	RA 20 -12 -PL
Thoroughfare Type	RA
Right of Way Width	20
Pavement Width	-12
Transportation	-PL

Thoroughfare Types	
Rear Alley	RA
Street	ST
Side Road	SR
Commercial Street	CS
Transportation Types	
Parking Lane(s)	PL / 2PL
Bike Lane(s)	BL / 2PL

P. Street: ST-50-22

Barber Street: Phillips Street to Langford Avenue

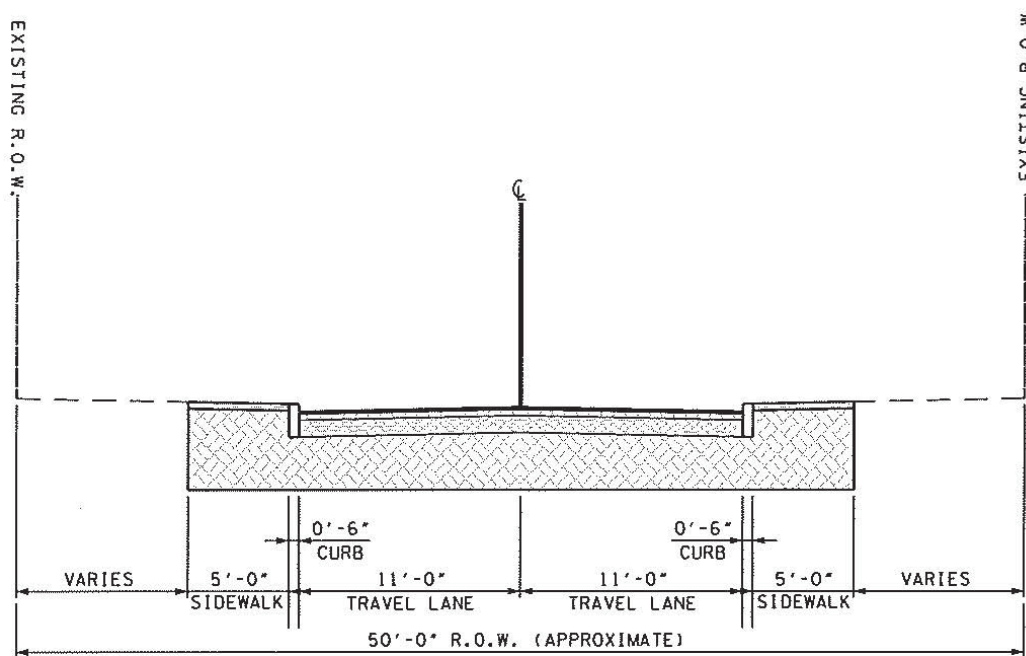

BARBER STREET (50' APPROX. PUBLIC R.O.W.)
PHILLIPS TO LANGFORD
LOOKING SOUTH

Thoroughfare Type	Street, ST-50-22
Right-of-Way Width	50'
Pavement Width	22'
Movement	Slow movement
Design Speeds	25 mph
Pedestrian Crossing Time	6.3 seconds
Traffic Lanes	2 lanes
Parking Lanes	NA
Bike Lanes	NA
Curb Radius	15'
Walkway Type	5' sidewalk
Planter Type	Upland or treatment planter, width varies
Curb Type	6"
Landscape Type	Tree spacing varies
Transportation Provision	Trolleys
Utilities	All underground

Key	RA 20 -12 -PL
Thoroughfare Type	RA
Right of Way Width	20
Pavement Width	12
Transportation	PL

Thoroughfare Types	
Rear Alley	RA
Street	ST
Side Road	SR
Commercial Street	CS
Transportation Types	
Parking Lane(s)	PL / 2PL
Bike Lane(s)	BL / 2PL

Q. Street: ST-58-36-2PL

Claude Street: Langford Avenue to Waterfront Drive

Dixe Street: Langford Avenue to Waterfront Drive

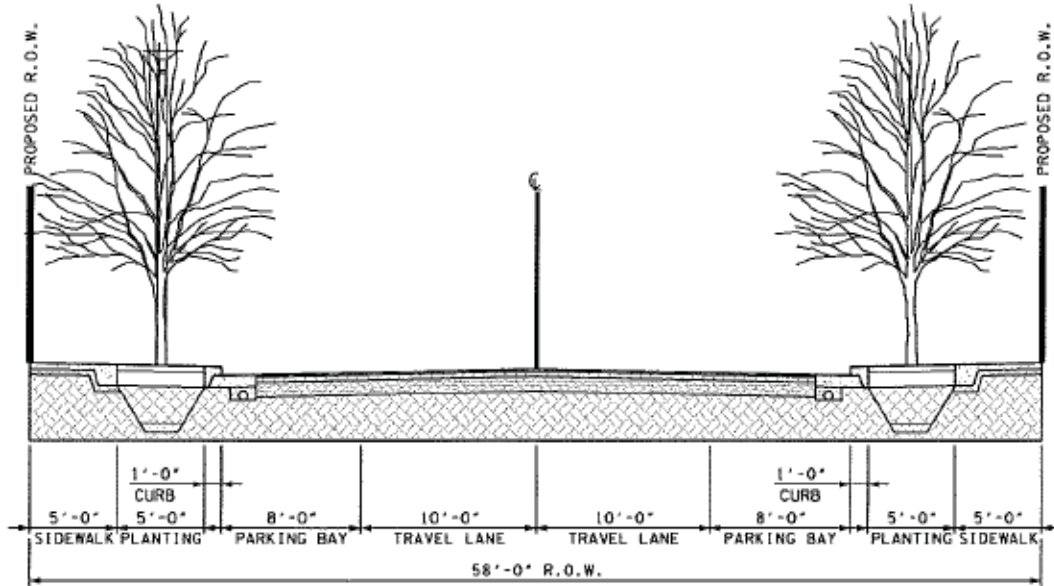

CLAUDE STREET (58' PUBLIC R.O.W.) LOOKING SOUTH
 DIXIE STREET (58' PUBLIC R.O.W.) LOOKING SOUTH

Thoroughfare Type		Street, ST-58-36-2PL
Right-of-Way Width	58'	
Pavement Width	36'	
Movement	Slow movement	
Design Speeds	25 mph	
Pedestrian Crossing Time	5.8 seconds	
Traffic Lanes	2 lanes	
Parking Lanes	Both sides @ 8' marked	
Bike Lanes	NA	
Curb Radius	15'	
Walkway Type	5' sidewalk	
Planter Type	5' wide treatment planter	
Curb Type	1'	
Landscape Type	Trees @ 20'-25' O.C.	
Transportation Provision	NA	
Utilities	All underground	

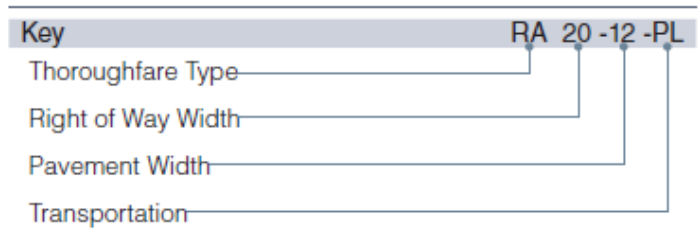

Thoroughfare Types	
Rear Alley	RA
Street	ST
Side Road	SR
Commercial Street	CS
Transportation Types	
Parking Lane(s)	PL / 2PL
Bike Lane(s)	BL / 2PL

R. Street: ST-44-22

Empire Street: Langford Avenue to Waterfront Drive

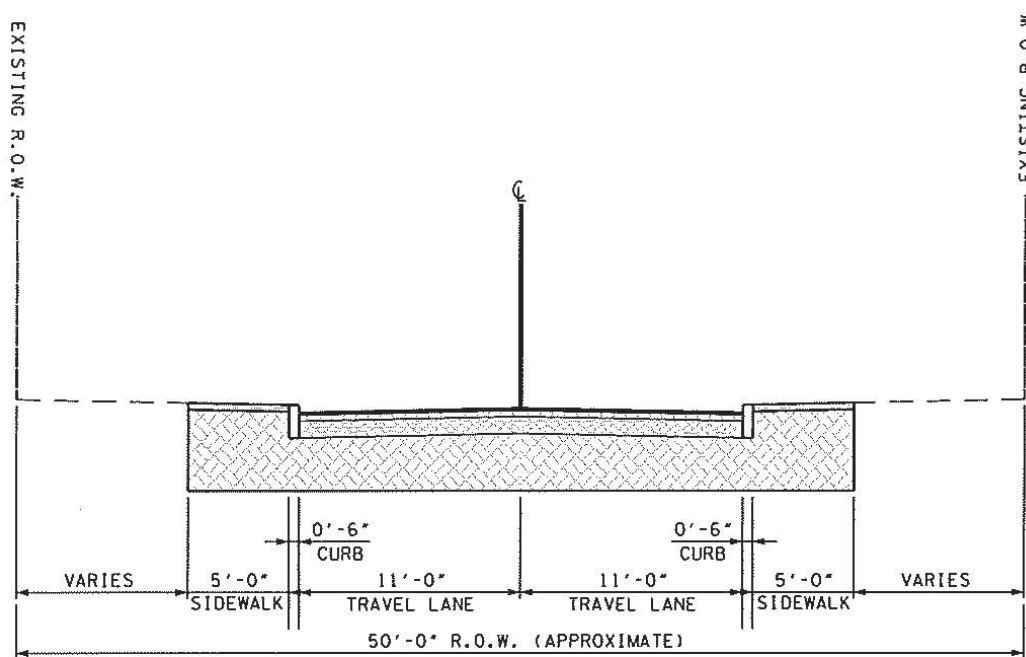

BARBER STREET (50' APPROX. PUBLIC R.O.W.)
PHILLIPS TO LANGFORD
LOOKING SOUTH

Thoroughfare Type	Street, ST-44-22
Right-of-Way Width	44'
Pavement Width	22'
Movement	Slow movement
Design Speeds	25 mph
Pedestrian Crossing Time	6.3 seconds
Traffic Lanes	2 lanes
Parking Lanes	NA
Bike Lanes	NA
Curb Radius	15'
Walkway Type	5' sidewalk
Planter Type	5' wide treatment planter
Curb Type	1'
Landscape Type	Trees @ 20'-25' O.C.
Transportation Provision	NA
Utilities	All underground

Key	RA 20 -12 -PL
Thoroughfare Type	RA
Right of Way Width	20
Pavement Width	-12
Transportation	-PL

Thoroughfare Types	
Rear Alley	RA
Street	ST
Side Road	SR
Commercial Street	CS
Transportation Types	
Parking Lane(s)	PL / 2PL
Bike Lane(s)	BL / 2PL

S. Street: ST-62-38-2PL

Foggy Bottom Street: Sevier Avenue to Waterfront Drive

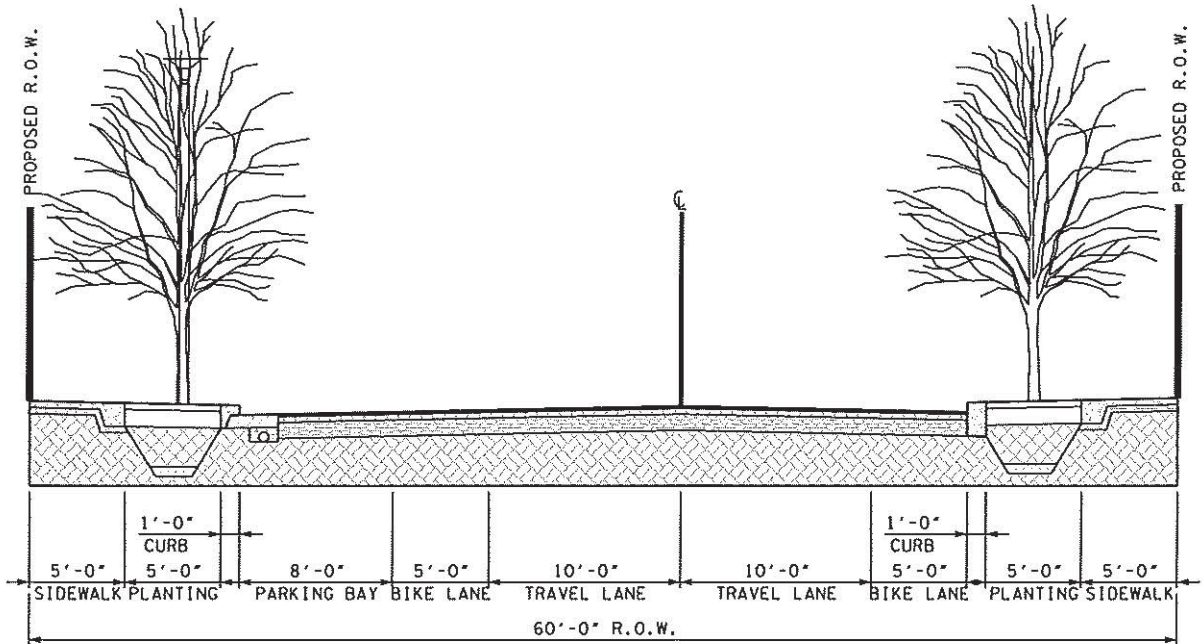

LINCOLN STREET (60' PUBLIC R.O.W.)
LOOKING SOUTH

Thoroughfare Type	Street, ST-62-38-2PL
Right-of-Way Width	60'
Pavement Width	38'
Movement	Slow movement
Design Speeds	25 mph
Pedestrian Crossing Time	5.8 seconds
Traffic Lanes	2 lanes
Parking Lanes	1 side @ 8' marked
Bike Lanes	Both sides @ 5' marked
Curb Radius	15'
Walkway Type	5' sidewalk
Planter Type	5' wide treatment planter
Curb Type	1'
Landscape Type	Trees @ 30'-35' O.C.
Transportation Provision	Trolleys
Utilities	All underground

Key	RA 20 -12 -PL
Thoroughfare Type	
Right of Way Width	
Pavement Width	
Transportation	

Thoroughfare Types	
Rear Alley	RA
Street	ST
Side Road	SR
Commercial Street	CS
Transportation Types	
Parking Lane(s)	PL / 2PL
Bike Lane(s)	BL / 2PL

4.1.6. Riverscape Standards



A. Vision and Intent

Knoxville's riverfront is one of its greatest assets. Currently populated with industrial use and storage, there are hardly any public access or amenities associated with the river on its south shore. Developing a continuous experience along the riverfront is imperative to the economic, cultural and recreational identity for South Knoxville. It is also a great benefit for the north shore tenants as their views across the river could improve significantly, consequently raising quality of living as well as real-estate values. The riverscape standards ensure access to the waterfront with pedestrian, bike and vehicular access, and improves river frontage to private properties. The following standards apply to the design and construction of riverbanks in conjunction with best management practices as they apply to erosion control, flood protection, and habitat protection and/or improvement.

The intent of the Riverfront Setback is to ensure:

The provision of an adequate amount of landscape coverage for habitat, water quality, erosion control and scenic quality expressed by the community:

1. Proper riverbank stabilization to prevent property erosion and loss;
2. Proper space for potential storm water drainage and utility corridors;
3. Continuous ADA pedestrian and bicycle access along the riverfront with regular connections to lanes, streets or roads perpendicular to the river edge expressed by the community;
4. A continuous green riparian corridor proportional in scale to adjacent buildings;
5. Maintenance vehicle access; and
6. Prevention of non-river-related or non-river-dependant structures.

B. Riverbank

1. **Riverwalk Path**
20 foot wide shared use pavement.
2. **Riverwalk Trees**
Trees limbed up to allow views under at 30 feet to 50 feet spacing.
3. **Riverwalk Lighting**
Continuous lighting to allow pedestrian use at night.
4. **Riverwalk Furniture**
Benches and trash receptacles at regular intervals.
5. **River Bank Lower**
Rip-Rap and/or rock-filled wire mattresses from river bottom to normal high.
6. **River Bank Upper**
Bioengineered slopes above normal high.
7. **River Bank Slopes**
No steeper than 1 in 2.5 unless in rock or mechanically stabilized.
8. **River Bank Storm Drain Outlet**
Headwall angle to match bank slope, include scour protection.
9. **River Bank Vegetation**
Clusters of trees, 90%-100% coverage of grass, groundcover or shrub species adapted to riparian conditions.
10. **River Bank Clear View**
With the exception of tree trunks, allow for unobstructed views from riverwalk over river bank vegetation to river surface.
11. **Permitted Uses**
Decks, boat ramps, vessel mooring structures, docks, piers, gangway to marina, walkways, boardwalks, landscape, lighting and furniture elements, utility and stormwater facilities, non habitable shelter structures as accessories to marinas.
12. **Non-Permitted Uses**
Parking , filling, waste storage.

C. Riverwalk

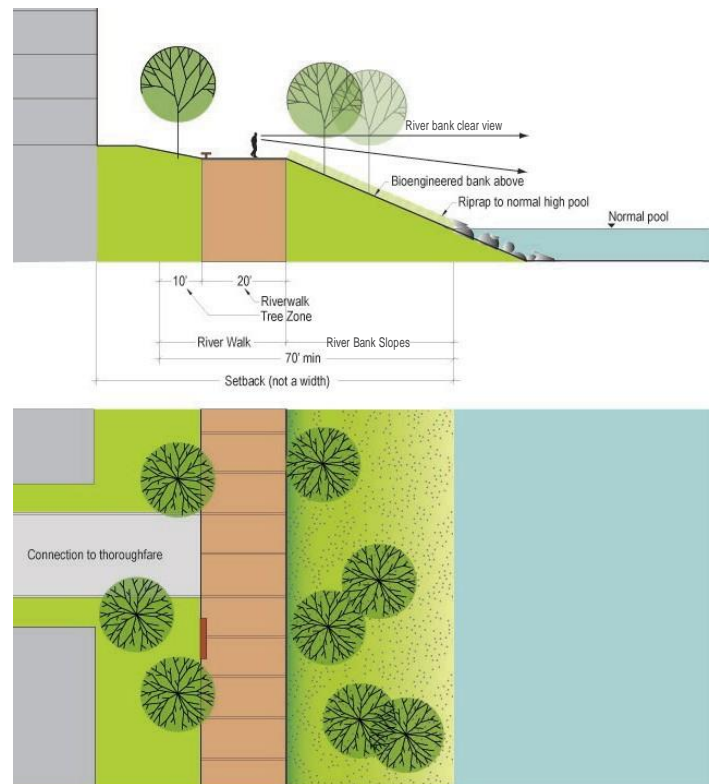

4.1.7. Stream Buffer Standards

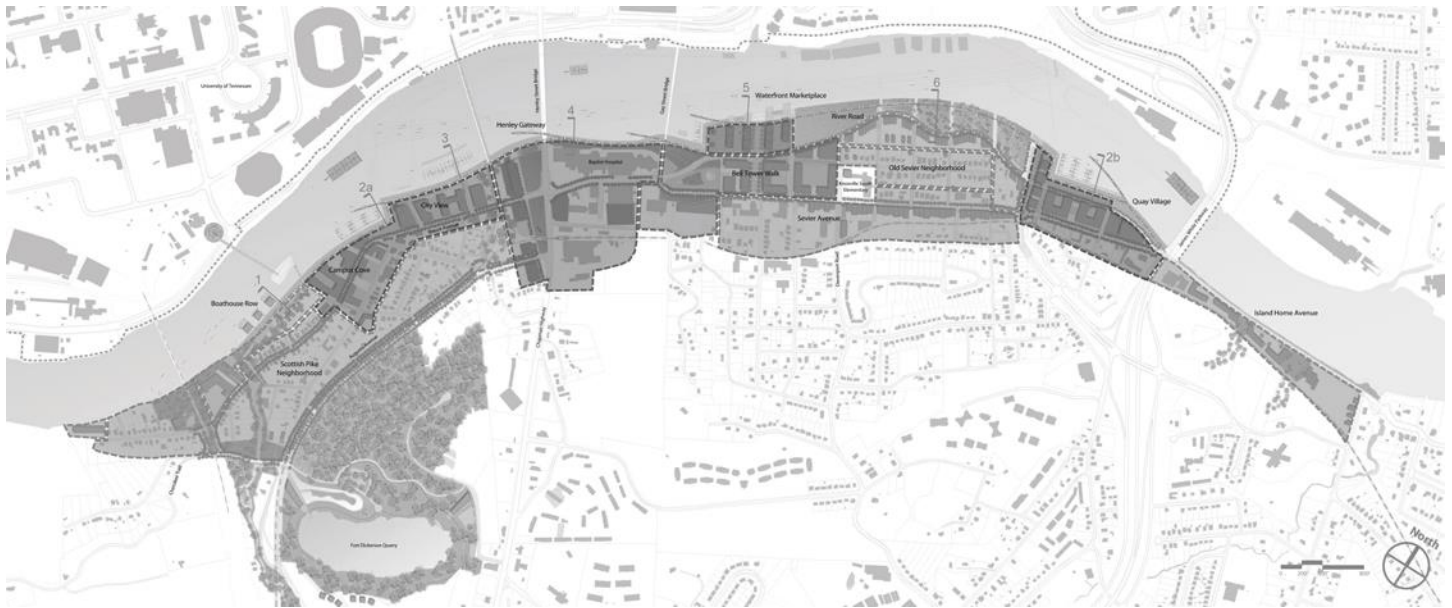

A. Vision and Intent

South Knoxville's Goose Creek is intended to become a continuous green corridor that would connect people, bicycle riders, and wildlife from the waterfront up to the great open space at Fort Dickerson. The intent of the stream buffer standard is to ensure the provision of an adequate amount of landscape coverage for water quality, drainage and flooding, erosion control and stream bank stabilization, wildlife habitat, and scenic quality. By creating a stream buffer and restricting impervious surfaces, the streams are allowed to maintain a natural flow and storm water drainage. Restricting polluting uses will maintain water quality, while protected and/or improved riparian vegetation will ensure bank stabilization, sediment control, and pollution filtration. Improved water quality in streams will also allow for a safe recreational use of the Tennessee River and its waterfront.

4.1.8. Marina Standards



A. Vision and Intent

To establish minimum requirements for the siting, design, construction, and operation of marinas to serve the needs of boaters, while properly managing the State's natural resources, and protecting public health.

B. Siting

1. Marina Types

Permitted uses include marinas as accessories to mixed use development, for mooring boats and/or for fueling boats.

2. Marina Siting

Satisfy TVA, USACE, and State of Tennessee requirements.

Marina must minimize adverse effects on flow of water, commercial boat traffic and recreational rowing, minimize dredging and minimize accumulation of sediments.

3. Marina Size

As a guide, the riverside width of marina shall not project past the TVA and USACE assessment line as shown on the regulating plan.

Minimum clear distance of fairway aisle between finger float ends shall be minimum 1.5 times the length of the longest finger float but not less than 40'.

Marina length may be no longer than the property it serves.

4. Marina Depth

Minimum 6 feet of water at normal low pool, max no deeper than river channel. If excavation is required to accomplish the minimum depth, TVA, USACE, or the State of Tennessee may require sediment testing to determine environmental impact of any potential dredging.

5. Permitted Uses

Marinas as accessories to mixed use development, for mooring boats and/or for fueling boats.

6. Non-Permitted Uses

Dry boat maintenance, dry lifts, dry boat storage, residential boat houses, ~~motorized boat storage~~, covered moorings, in-water maintenance such as pressure washing or hull scraping.

C. Dimensions

1. Gangway

Gangways shall have a minimum clear width of 3 feet and at least one gangway slope must meet ADA requirements. Gangways shall be aluminium with guardrails, handrails and kick plate. Gangways shall be hinged at one end and sliding at the other. Gangways shall be capable of disconnecting and stowing during flood events.

2. Top Landing

Top landing shall have a minimum of 5 feet by 5 feet platform with guardrail and lockable gate.

3. Utilities

All utilities servicing floats shall have a shut off and/or emergency disconnect adjacent to the top of the gangway.

Potable water and fire suppression lines shall not be combined.

4. Main Floats

Main floats shall be not less than 5 feet in unobstructed width.

5. Finger Floats

Finger floats shall be not less than 3 feet unobstructed in width.

In-River Marina Configuration #1

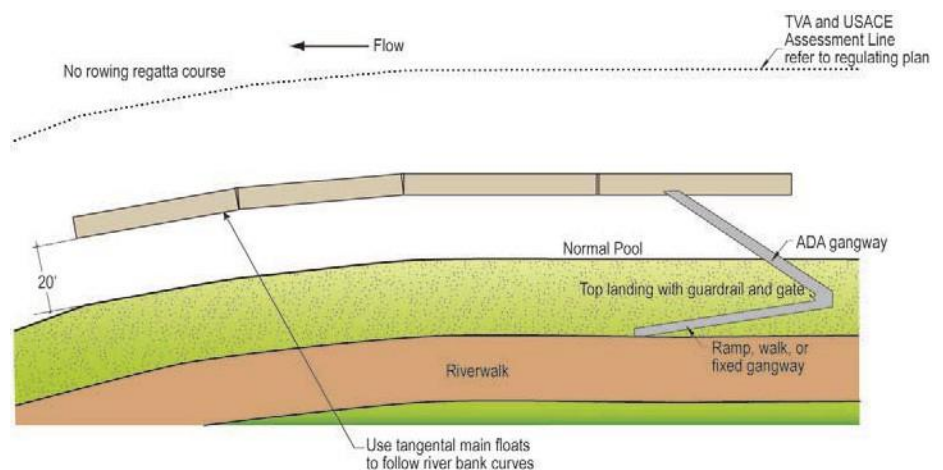

In-River Marina Configuration #2

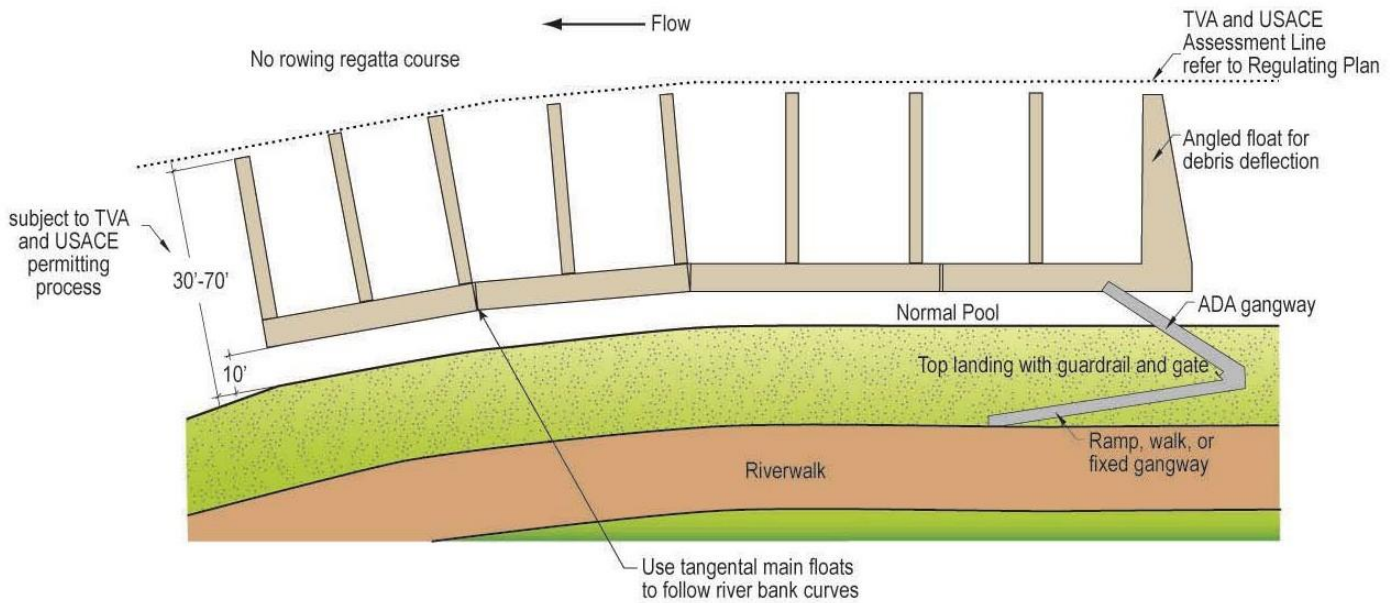

In-Bank Marina Configuration

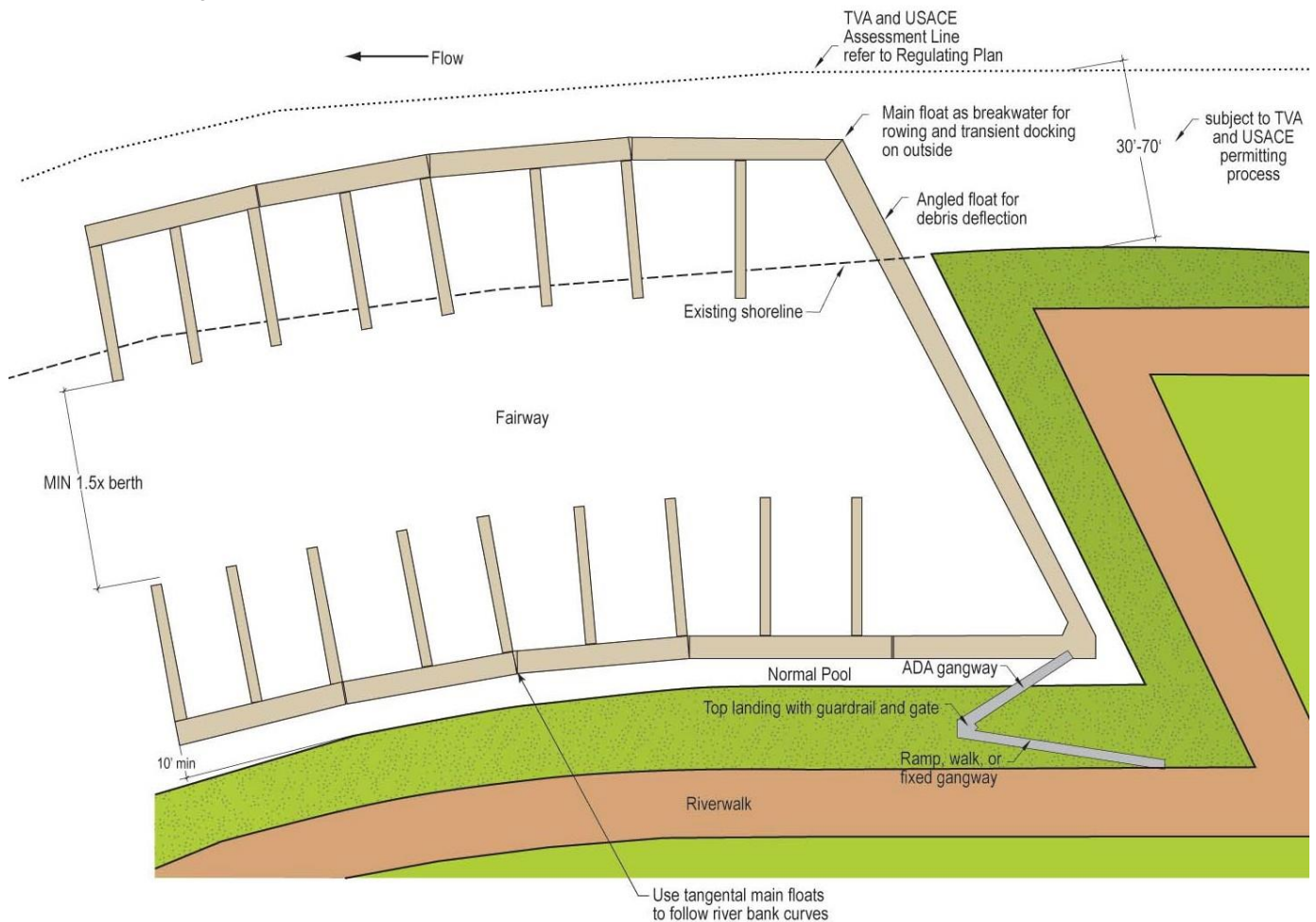

D. General Standards

1. Structural Loads

a. Debris Deflection

Locate float systems and/or breakwater to deflect floating debris around marina.

b. Flotation Materials

Timber logs and wood flotation shall not be used. Concrete, steel, polyethylene, encapsulated foam, pontoon systems may be used and all floats used for fuel docks shall be concrete impervious to fuel spillage.

c. Impact Loads

Waterfront structures shall be designed for impact loads from vessels and floating debris up to a ~~4-in~~ 100 year flood.

d. Flotation and Anchoring

Steel guide piles or hinged steel arms must enable marina to float up to a 4:100 year flood elevations plus freeboard. Fixed Marinas are not permitted.

2. Environmental Considerations

a. Sewage Management

No sewer discharge to any waters. One fixed-point collection system at centrally located pumpout station to discharge to city sewer.

b. Fuel Management

If fuel facilities are proposed, only land based underground storage tank out of floodway is permitted.

3. On-Shore Components

a. Off Street Parking

Not required for marinas as an accessory to residential buildings.

b. Loading Area

Allow service vehicle access to top of gangway landing.

c. Signs

Signs other than for navigation and regulation are not permitted.

4.1.9. Glossary and Definitions

The following terms are defined for the purpose of the Knoxville South Waterfront. Terms not defined here may be defined elsewhere in the Knoxville Zoning Ordinance. In such case, the definition contained in the Zoning Ordinance will be used.

A

ALBEDO (solar reflectance)

The ratio of the reflected solar energy to the incoming solar energy over wavelengths of approximately 0.3 to 2.5 micrometers. A reflectance of 100% means that all of the energy striking a reflecting surface is reflected back into the atmosphere and none of the energy is absorbed by the surface. See ASTM Standard E903.

ALLEY

A minor street right-of-way, dedicated to public use, which affords a secondary means of vehicular access to the back or side of properties otherwise abutting a public street, and which may be used for public utility purposes.

ANCHORAGE

Areas in which vessels are held by means of anchors or similar devices which are removed from the bottom and carried aboard the vessels once they are underway. (from Delaware Rules and Regulations)

ARCADE

An open, roofed ground floor passageway supported by columns, piers or pillars.

AWNING

A cantilevered, projected or suspended cover over the sidewalk portion of the street. Also, roof-like coverings, usually of canvas or metal and often adjustable, placed over the sidewalk.

B

BALCONY

An exterior platform that projects from the wall of a building and is surrounded by a railing, balustrade, or parapet.

BAY OR BAY WINDOW

Generally, a u-shaped enclosure, extending the interior space of the building outward of the exterior building wall. A combination of 3 windows or walls units joined together that project outwards. The center unit is parallel to the wall and the two units each side are usually 45° or 90° (right angles) to the wall but can be any angle.

BERTH

A place where a vessel may be secured to a fixed or floating structure and left unattended.

BIKE LANE

A dedicated bicycle lane running with moderate-speed vehicular thoroughfare demarcated by striping or other means.

BIOENGINEERING SLOPES

Preventative measures that are effective in stabilizing banks and reducing sedimentation of nearby water bodies. Structures made of natural and biodegradable materials, like fiber mats, coir fiber logs, wood logs, or synthetic geotextiles reduce the amount and speed of runoff from storm events and provide erosion and flood protection.

BLOCK

A surface land area which is separated and distinguished from other surface land areas by visible physical boundaries such as streets, railroads, rivers, or other physical barriers. Blocks shall be measured at the frontage lot line (along the required build to line).

BOAT HOUSE

A specific type of vessel designed to be moored to a main float system to enclose and protect another vessel or vessels from the elements.

BREAKWATER

A structure, parallel to the shore, that protects a shore area, harbor, anchorage, or basin from waves.

BULKHEAD

A vertical walled structure or partition intended to retain or prevent sliding of the land, or to provide an interface between land activities and those which occur in the water, or intended to protect the upland against damage from wave action.

BUFFER ZONE

A naturally undisturbed, vegetated and pervious streamside zone that is protected from clearing, grading, filling, paving, building or other destruction of the naturally vegetated state.

BUILDING COVERAGE

Building coverage includes the total lot area covered by a roof, floor or other structures, except eaves. Building coverage is measured to the outside faces of exterior walls, at any height, whichever produces the largest area. Carports, sheds, side and rear porches, covered pedestrian-walkways, breezeways, arbors, gazebos and covered patios are included in building coverage calculations.

BUILDING HEIGHT

The vertical extent of a building measured in feet and stories. Height limits do not apply to masts, belfries, clock towers, chimney flues, water tanks, elevator bulkheads or similar structures. Building height shall be measured from the average grade of the building face on the principal property frontage to the highest ridge line of the structure.

C

CANOPY TREE

A tree with a wide spread of branches that can provide shade in summer.

CHANNEL STORAGE CAPACITY

The volume of a stream network within its banks.

COMMON LOT LINES

Lot lines shared by adjacent private lots.

CIVIC GREEN OR SQUARE

The term civic green is generally used to describe a formally configured public lawn or park that is primarily green. The term square is generally used to describe spaces that are primarily a hard paved surface.

D

DECK

That element of a waterfront structure which provides the lowest floor level or platform for use, under which occur only the structural support system for the structure, and no usable space.

DOCK

A fixed or floating decked structure where a vessel or vessels may be secured either temporarily or indefinitely.

DORMERS

Small, roofed ancillary structures with windows providing light and air to occupiable space within the roof. Dormers are permitted and do not constitute a story so long as they do not break the primary eave line, are individually less than 15 feet wide, and are collectively not more than 60% of the unit's required building line facade.

DRY BOAT STORAGE

A building, which is either open or subdivided into stalls and is used primarily for the dry storage of vessels.

F

FENESTRATION

An opening in the building wall allowing light and views between interior and exterior. Fenestration is measured as glass area (excluding window frame elements with a dimension greater than one inch) for conditioned space and as open area for parking structures or other un-conditioned, enclosed spaces.

FENCE

A solid fence made of wood, masonry or semitransparent chain link along alleys and common lot lines.

FINGER FLOAT

A narrow float connected to a main float, which defines the length of a berth and separates that berth from adjacent berths.

FIVE HUNDRED YEAR FREQUENCY STORM

~~A storm event with a one-fifth of one percent chance of being equaled or exceeded in any given year. Defined to be 7.6 inches in 24 hours using a NRCS Type II rainfall distribution, or as the Engineering Director may establish based upon scientific and engineering information.~~

FLOAT

A floating structure normally used as a point of transfer for passengers and/or goods, and/or for berthing purposes.

FLOAT SYSTEM

A combinations of a main float and finger floats, either open or covered, designed to be used to moor vessels.

FLOOR to AREA RATIO (FAR)

The ratio of building area to parcel area. FAR is calculated by adding all of the areas of each floor of the building together and dividing by the gross area of the parcel on which the building is sited.

FLOODPLAIN

For a given flood event, that area of land temporarily covered by water, which adjoins a watercourse and which is necessary for the conveyance of the given flood event.

FOOTPRINT

The area that the ground floor of a building covers.

FRONTAGE

The relationship of the building to a public way. The frontage line refers to the front setback line which may also be the required build to line. The private frontage is the area between the building and the private property line. The public frontage is the area between the private property line and vehicular lanes.

G

GANGWAY

A bridge affording access from shore, or a waterfront structure to a main float.

GARAGE ENTRY (NON-RESIDENTIAL)

An opening (with curb cut) in the building facade where vehicles may enter into the block interior for general parking and business servicing.

H

HABITABLE FLOOR

Any floor usable for living purposes, which includes working, sleeping, eating, cooking or recreation, or a combination thereof, but not a floor used only for storage purposes.

L

LEED

Leadership in Energy and Environmental Design Green Building Rating System by the U.S. Green Building Council (USGBC) defines and measures that should qualify as a "green building."

LOT

A parcel of land which is or may be occupied by a building and its accessory buildings or use customarily incidental thereto, together with such yards or open spaces within the lot lines as may be required by this ordinance.

M

MAIN FLOAT

A float connected by a gangway to the shore or to a waterfront structure, being tied down laterally by an anchorage system, normally of piles, but free to move vertically, and which provides access to berths. Finger floats may be attached to one or both sides of main floats.

MARINA

Any publicly or privately owned dock, basin or wet boat storage facility built to accommodate more than 2 boats and providing permanent or temporary docking space.

MAXIMUM BUILDING OUTLINE

The maximum dimension by which the proposed building must fit.

MINIMUM BUILDING OUTLINE

The least dimension by which the proposed building must fit.

MOOR

The act of securing a vessel into a berth at a pier, wharf, or float system.

O**ONE HUNDRED YEAR FREQUENCY STORM EVENT**

~~A storm event with a one percent chance of being equaled or exceeded in any given year. Defined to be 6.5 inches in 24 hours using a NRCS Type II rainfall distribution, or as the Engineering Director may establish based upon scientific and engineering information.~~

P**PARKING, RESERVED**

Parking not available to the public, but only to specifically identified users (either a single user per space or a set of users for a group of spaces), whether for free or at a fee, that shall not exceed the prevailing market rate.

PARKING, SHARED

Parking available to the public on an unreserved basis for free, or at the same fee for all users, which shall not exceed the prevailing market rate. Time limits may be imposed to ensure turn-over. Hours of public availability may also be restricted.

PERCOLATE

A practice designed to promote the recharge of groundwater by containment and concentration of stormwater in porous soils. Also referred to as Infiltration.

PERMEABLE PAVEMENT

A pavement system designed to achieve water quality and quantity benefits by allowing movement of stormwater through the pavement surface and into a base/sub base reservoir. Examples include pervious concrete, porous asphalt, and permeable paving blocks

PLAZA

An area devoted strictly to pedestrian use which provides access to two or more businesses. Such space shall be surfaced with material generally used for pedestrian traffic and available to the general public during hours which adjoining establishments are open for business. A public open space with a hard surface. See also CIVIC GREEN or SQUARE.

PRINCIPAL FRONTAGE ROAD

The primary street that accesses the main building entrance.

R**REGULATING PLAN**

Part of the code that is the key for the building development standards that provide specific information for the disposition of each building site. The Regulating Plan shows how each site relates to streets, the overall Knoxville South Waterfront and the surrounding neighborhood.

REQUIRED BUILD TO LINE

The building shall be "built-to" the required building line as shown on the Regulating Plan. The build to line is a requirement, not a permissive minimum as is a set-back. The build to line for each site is shown on the applicable Regulating Plan. The minimum length of building that is required to be built-to is shown on the appropriate building siting and configuration standard.

RESERVED PARKING

See PARKING, RESERVED

R. O. W. - Right of Way

An area used as a public way, measured from boundary line to boundary line, which may also accommodate public utilities.

S**STOOP**

A frontage type where the raised entry platform is on the principal frontage and the first story is above the level of the ground creating a change in elevation.

STORMWATER

The increased volume of water that flows over land areas to collect in lakes and streams during and just after storms.

STORY, STORY HEIGHT

That portion of a building included between the upper surface of a floor and upper surface at the floor or roof next above

STREET

The entire width between boundary lines of every way when any part thereof is open to the use of the public for purposes of vehicular travel.

STREET FRONTAGE

The lot line coincident with the required build to line or that portion of the building that is coincident with the required build to line as required by the code. The lineal distance is measured horizontally and in feet.

STREETSCAPE

Improvements to a property, including paving, tree and/or other decorative plantings, lighting, and the placement of street furniture, within the street.

V

VESSEL

An all-inclusive term to describe a craft which travels on the water, and includes but is not limited to pleasure boats, commercial shipping, fishing boats, house boats, boat houses and barges, but does not include floats or other water borne structures normally anchored in place and stationary.

VIEW CORRIDORS

An unobstructed picture of the landscape. Critical view corridors in the Knoxville South Waterfront Plan emanate from the public streets and primary civic spaces and parks towards the river.

W

“WHERE CLEARLY VISIBLE FROM THE STREET”

Many requirements of the code apply only where the subject is “clearly visible from the street.” Note that the definition of street includes squares, civic greens, parks, and all public space except alleys.

WINDOW SIGN

For the purpose the South Waterfront District, a window sign shall be a sign attached to, painted on, or etched into a window or displayed within 12 inches (measured horizontally) of the window and are legible from outside of the window.